



Product Catalog
Epilepsy Surgical • Neurosurgical
& Neuromonitoring Devices

WELCOME!

Welcome to Ad-Tech's catalog of products for the surgical treatment of epilepsy and for neurosurgery. We wish to thank you for your support and for choosing Ad-Tech.

PRODUCT REGISTRATIONS

Ad-Tech Medical Instrument Corporation is proud to be an FDA and ISO registered company. Unless otherwise stated, all products within this catalog meet the regulatory requirements of the FDA, the Therapeutic Products Directorate of Canada and the Medical Device Directive of the European Union. Our subdural, depth and sphenoidal electrodes have governmental clearance to be placed in the body for up to 30 days. To determine the regulatory status of Ad-Tech products in any country, or to receive a copy of the applicable indication for use statements, please contact Ad-Tech or your local Ad-Tech distributor.

REFERENCES

Ad-Tech has over 100 medical journal articles that represent the use of our products. Please contact Ad-Tech to receive a reprint. Please note that the authors do not present a commercial description.

MR CONDITIONAL

Ad-Tech tested an assortment of electrodes in a Siemens Trio (actively shielded whole body 3T magnet). In accordance with ASTM F2052-02 Standard Text Method for measurement of Magnetically Induced Displacement Force on Medical Devices in the Magnetic Resonance Environment (2003). For a more complete MR report, contact your Ad-Tech representative.

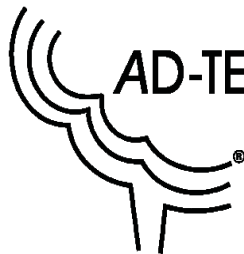

AD-TECH[®] MEDICAL INSTRUMENT CORPORATION

1901 WILLIAM STREET, RACINE, WI 53404 U.S.A.

Phone: 262-634-1555

Email: sales@adtechmedical.com

Fax: 262-634-5668

Website: www.adtechmedical.com

Toll Free: 800-776-1555

TABLE OF CONTENTS

	Page
<u>SUBDURAL ELECTRODES</u>	
<i>Contoured Subdural Grid Electrodes</i>	4
<i>Single-Tail Subdural Grid Electrodes</i>	5
<i>Perpendicular-Tail Subdural Grid Electrodes</i>	6
<i>Multi-Strip & Split-Grid Subdural Electrodes</i>	7
<i>Subdural Grid Electrodes</i>	8
<i>Temporal Lobe Subdural Grid Electrodes</i>	10
<i>“L” & “T” Shaped Subdural Strip & Grid Electrodes</i>	11
<i>Subdural Strip Electrodes</i>	12
<i>Narrow-Body Subdural Strip Electrodes</i>	13
<i>3D Style Subdural Strip Electrodes</i>	13
<i>Macro-Micro Strip Electrodes</i>	14
<i>Dual-Sided Interhemispheric Subdural Strip & Grid Electrodes</i>	15
<u>EPIDURAL SPINAL & INTRAOPERATIVE MAPPING ELECTRODES</u>	
<i>Intraoperative Monitoring Subdural Strip Electrodes</i>	16
<i>Intraoperative Monitoring Electrodes with Attached Cables</i>	17
<i>Intraoperative Mapping Electrode System</i>	18
<i>Epidural Spinal Electrodes</i>	18
<u>DEPTH & FORAMEN OVALE ELECTRODES</u>	
<i>Macro-Micro Depth Electrodes</i>	19
<i>Behnke Fried Depth Electrodes</i>	20
<i>Foramen Ovale Electrodes</i>	21
<i>Spencer® Probe Depth Electrodes</i>	22
<u>DEPTH ELECTRODE PLACEMENT KITS & ACCESSORIES</u>	
<i>Depth Electrode Placement Kits</i>	24
<i>Depth Electrode Cannulas</i>	24
<i>Depth Electrode Anchor Bolts</i>	25
<i>Disposable Drill Kits</i>	25
<i>Passing Needles</i>	26
<u>SPHENOIDAL ELECTRODES</u>	
<i>Sphenoidal Electrodes</i>	26
<u>SUBPIAL TRANSECTORS</u>	
<i>Subpial Transector</i>	27
<u>ELECTRODE CONNECTION SYSTEMS</u>	
<i>Electrode Cable Splitter Box</i>	27
<i>Lightweight Electrode Connection Systems</i>	28
<u>DISPOSABLE BRAIN BIOPSY NEEDLES & ELECTRODE ACCESSORIES</u>	
<i>Disposable Brain Biopsy Needles</i>	30
<i>Brain Biopsy Needle Guides</i>	30
<i>Disposable Reducing Guide Kits</i>	30
<u>CRANIAL NERVE MONITORING ELECTRODES</u>	
<i>Intraoperative Cranial Nerve Electrodes</i>	31
<u>IVES SCALP ELECTRODES</u>	
<i>CT Compatible Scalp Electrodes</i>	32
<i>Subdermal Wire Electrodes</i>	33
<u>GENERAL INFORMATION</u>	
<i>Product Registrations & References</i>	2



* Subpial Transectors, Cranial Nerve Electrodes, and Ives Scalp Electrodes are NOT CE Marked.



All specifications and claims are subject to change without notice. All products may be covered by one or more of the following USA Patents:
 5,375,594 - 6,004,262 - 6,415,168 - 6,629,900 - 6,656,152
 6,671,534 - 7,134,919 - 7,241,283 - 7,255,686 - 7,277,742
 7,322,954 - 7,425,142 - 7,465,292 - 7,536,215 - 7,607,224
 7,608,064
 Foreign Patents and Patents Pending

AD-TECH® EPILEPSY/LTM CONTOURED SUBDURAL GRID ELECTRODES

- Contoured shape may provide more flexibility to conform to the brain. Contact Ad-Tech to inquire if your favorite electrodes can also be contoured
- Numbered, platinum contacts, 4.0 mm diameter with a 2.3 mm exposure
- May be used with the single-tail passing needles: (see page 26)
- 10 mm contact spacing standard, additional spacing available
- Sterile; single-use only

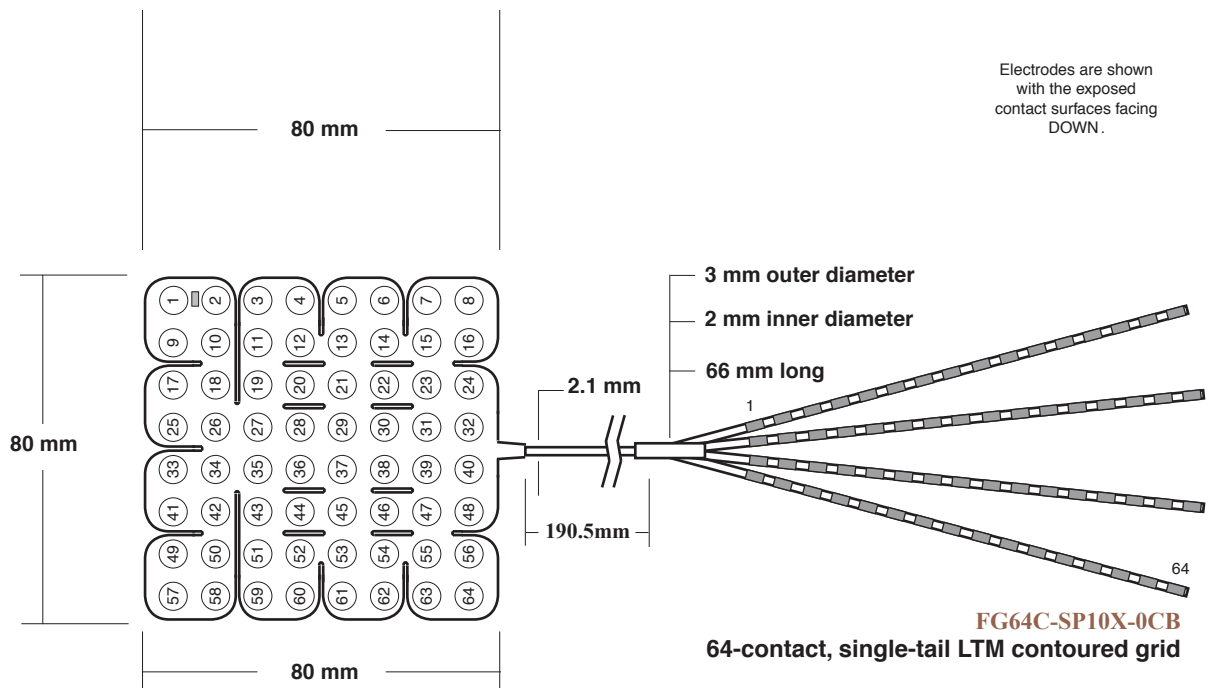
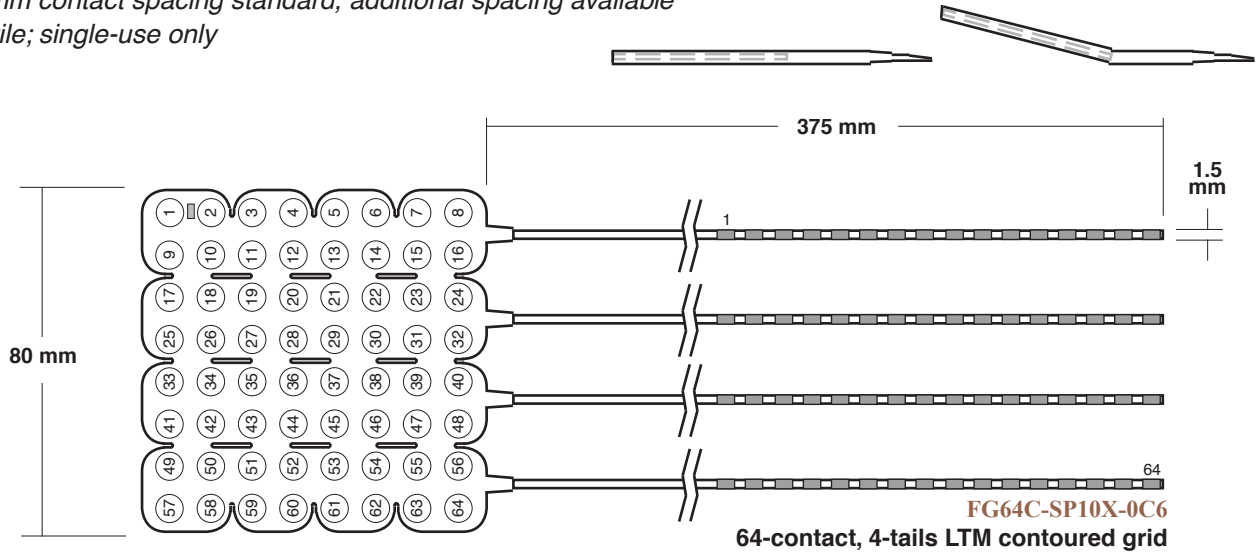

Electrodes are shown with the exposed contact surfaces facing DOWN.

Catalog Number	Description ¹
FG64C-SP10X-0C6	8 x 8, 4 tails LTM contoured grid
FG64C-SP10X-0CB	8 x 8, single-tail LTM contoured grid

CABRIO® Cable
L-SRL-64BDIN

RoTec™ Cable
L-RTL-64BDIN

TECH-ATTACH® Cable	Components Block Qty
L-DCL-64BDIN	DC-16X (4)

¹ Each electrode requires either the CABRIO, RoTec, or the TECH-ATTACH cable and the quantity of individual connector blocks as indicated.

■ Manufactured in U.S.A. All dimensions are approximate. All drawings are not to scale. Consult price sheets for current pricing.

AD-TECH® EPILEPSY/LTM SINGLE-TAIL SUBDURAL GRID ELECTRODES

- Tails terminate in standard configurations (uses TECH-ATTACH, CABRIO OR RoTec cables)
- Numbered, platinum contacts 4.0 mm diameter with 2.3 mm exposure
- May be used with the single-tail passing needles: (see page 26)
- Single-tail construction reduces the number of tunnels
- 60 cm tail length
- Sterile; single-use only

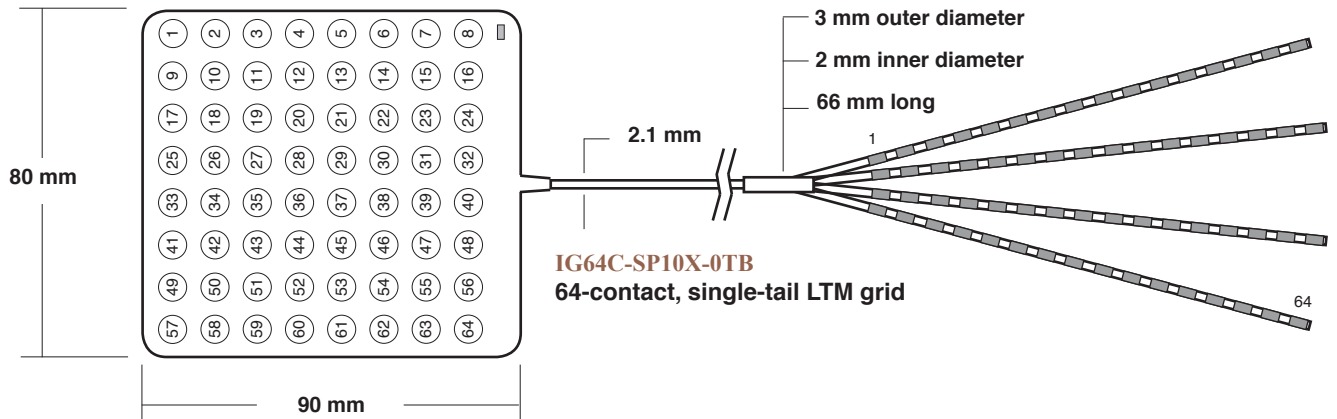
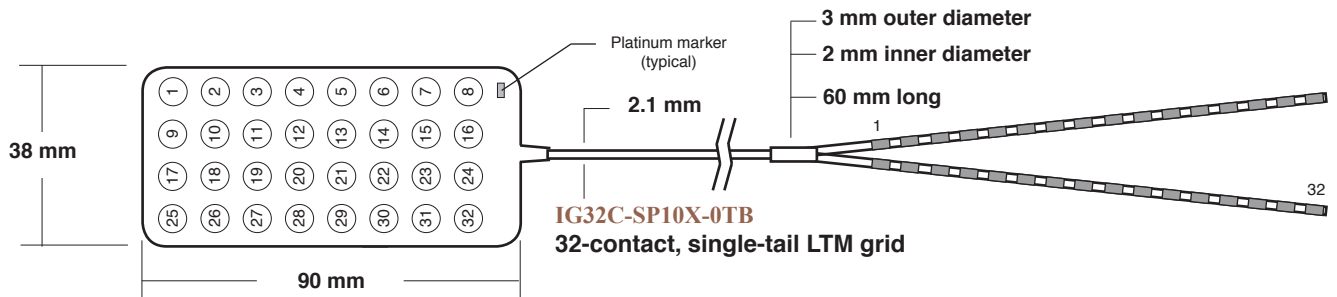
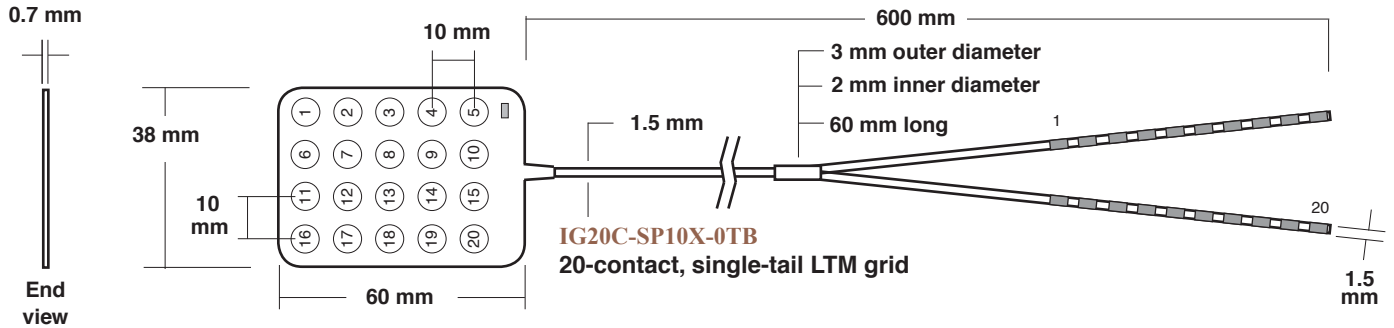

Electrodes are shown with the exposed contact surfaces facing DOWN.

Catalog Number

Description¹

IG20C-SP10X-0TB	4 x 5 LTM grid
IG32C-SP10X-0TB	4 x 8 LTM grid
IG64C-SP10X-0TB	8 x 8 LTM grid

CABRIO® Cable
L-SRL-20DIN
L-SRL-32BDIN
L-SRL-64BDIN

RoTec™ Cable
L-RTL-20DIN
L-RTL-32BDIN
L-RTL-64BDIN

TECH-ATTACH® Cable	Components Block	Qty
L-DCL-20DIN	DC-10X	(2)
L-DCL-32BDIN	DC-16X	(2)
L-DCL-64BDIN	DC-16X	(4)

¹ Each electrode requires either the CABRIO, RoTec, or the TECH-ATTACH cable and the quantity of individual connector blocks as indicated.

■ Manufactured in U.S.A. All dimensions are approximate. All drawings are not to scale. Consult price sheets for current pricing.



AD-TECH® EPILEPSY/LTM PERPENDICULAR-TAIL SUBDURAL GRID ELECTRODES

- Perpendicular tail design may allow for a smaller craniotomy
- Numbered, platinum contacts, 4.0 mm contacts with 2.3 mm exposure
- Sterile; single-use only
- Also available, contoured and slit

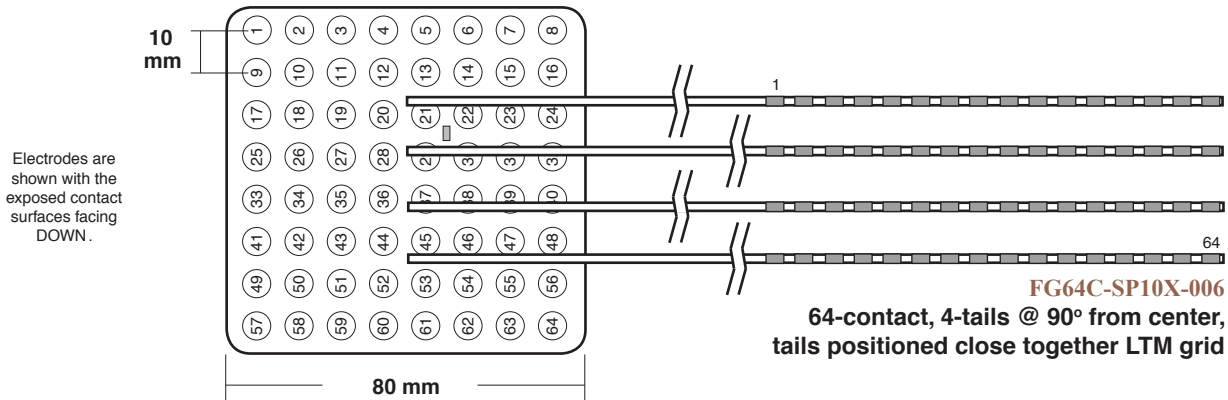
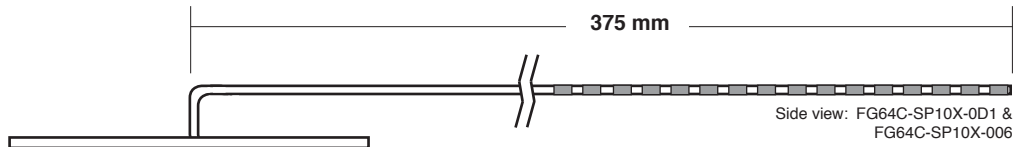
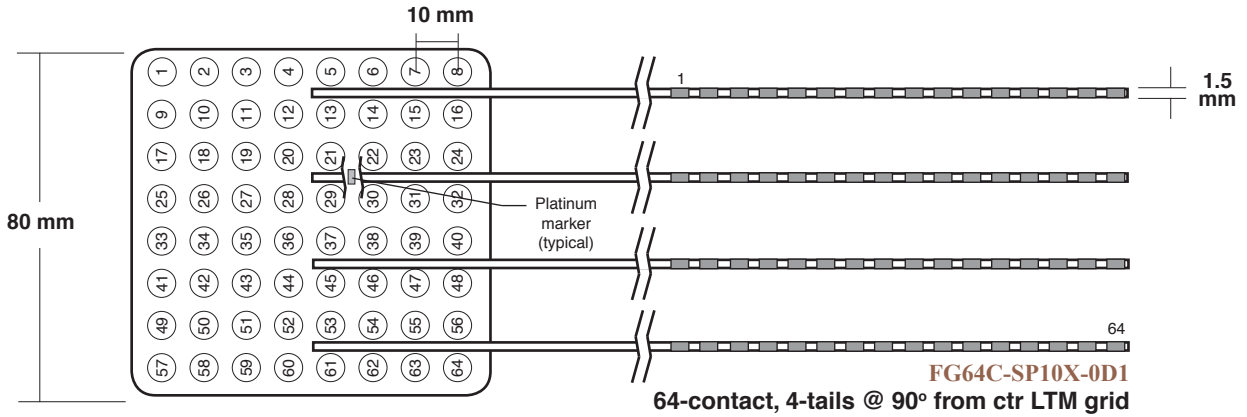

Catalog Number

Description¹

FG64C-SP10X-0D1

8 x 8, 4-tails, 90°-ctr LTM grid

FG64C-SP10X-006

8 x 8, 4-tails, 90°-ctr LTM grid²

CABRIO® Cable

L-SRL-64BDIN

RoTec™ Cable

L-RTL-64BDIN

TECH-ATTACH® Cable

L-DCL-64BDIN

Components

Block Qty

DC-16X (4)

¹ Each electrode requires either the CABRIO, RoTec, or the TECH-ATTACH cable and the quantity of individual connector blocks as indicated.

² The tails on this grid are positioned close to its center.

■ Manufactured in U.S.A. All dimensions are approximate. All drawings are not to scale. Consult price sheets for current pricing.

AD-TECH® EPILEPSY/LTM MULTI-STRIP & SPLIT-GRID SUBDURAL ELECTRODES

- Markers as shown
- Sterile; single use only
- Platinum contacts, 4.0 mm diameter with a 2.3 mm exposure
- Multi-strip and split-grid construction reduces the number of tunnels
- May be used with the single-tail passing needles (see page 26)
- 37.5 cm tail length

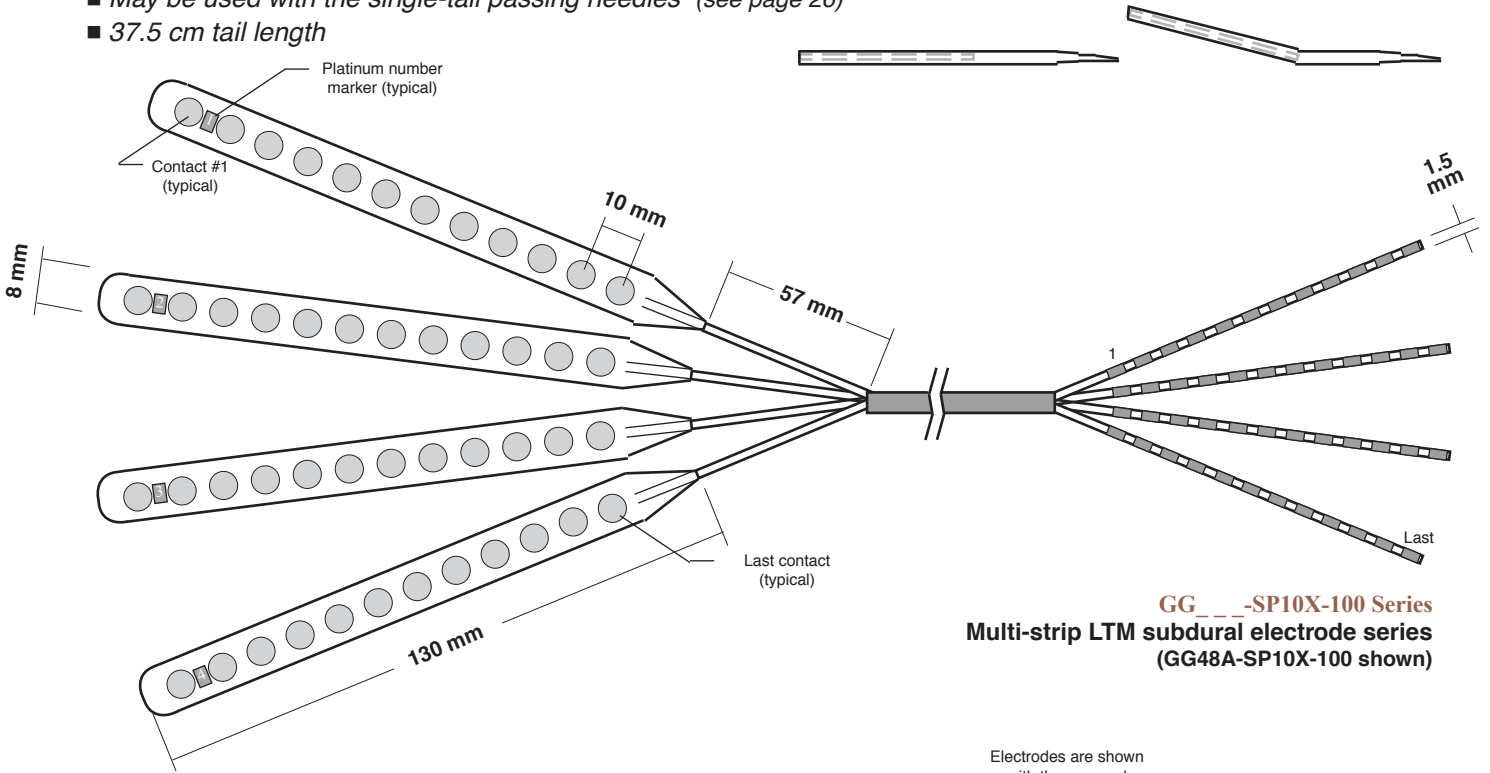

GG___-SP10X-100 Series
Multi-strip LTM subdural electrode series
(GG48A-SP10X-100 shown)

Electrodes are shown with the exposed contact surfaces facing DOWN.

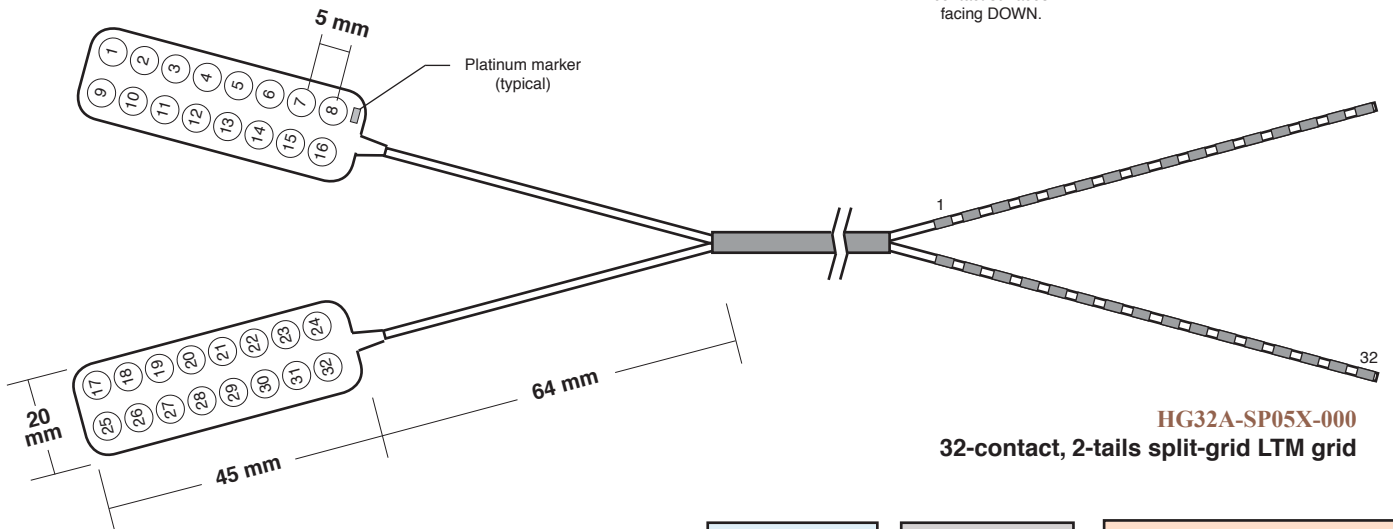

HG32A-SP05X-000
32-contact, 2-tails split-grid LTM grid

Catalog Number	Description ¹	No. of Contacts	Contact Spacing	CABLE		TECH-ATTACH®	
				CABRIO® Cable	RoTec™ Cable	Cable	Components Block Qty
GG32A-SP10X-100	4 x 1 x 8, 2-tails	32	10	L-SRL-32BDIN	L-RTL-32BDIN	L-DCL-32BDIN	DC-16X (2)
GG48A-SP10X-100	4 x 1 x 12, 4-tails	48	10	L-SRL-48DDIN	L-RTL-48DDIN	L-DCL-48DDIN	DC-12X (4)
HG32A-SP05X-000	2 x 2 x 8, 2-tails	32	5	L-SRL-32BDIN	L-RTL-32BDIN	L-DCL-32BDIN	DC-16X (2)

¹ Each electrode requires either the CABRIO, RoTec, or the TECH-ATTACH cable and the quantity of individual connector blocks as indicated.

- Manufactured in U.S.A. All dimensions are approximate. All drawings are not to scale. Consult price sheets for current pricing.
- Please contact your Ad-Tech representative for alternative designs or other special requirements

AD-TECH® EPILEPSY/LONG TERM MONITORING (LTM) SUBDURAL GRID ELECTRODES

- Epilepsy/LTM subdural electrodes are for monitoring/mapping the cortical surface for the surgical treatment of epilepsy
- Numbered, platinum or stainless steel contacts, 4.0 mm diameter with 2.3 mm exposure
- Sterile; single-use only
- Please contact your Ad-Tech representative for alternative designs or other special requirements (ie: 5mm spacing)
- All electrodes can be manufactured contoured and slit upon request

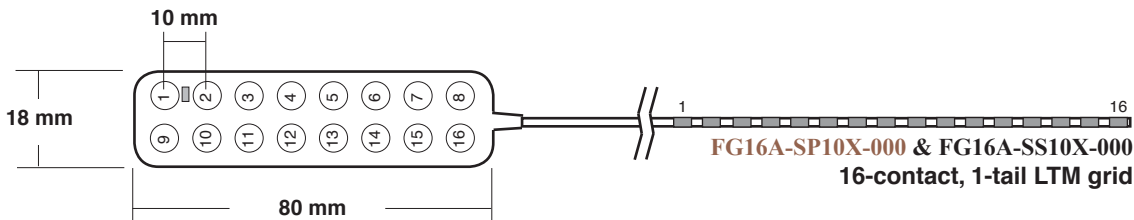
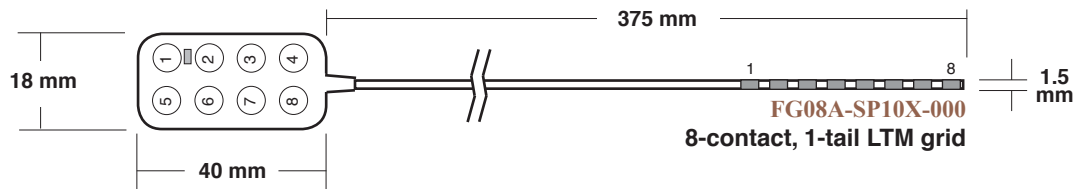

0.7 mm



End view

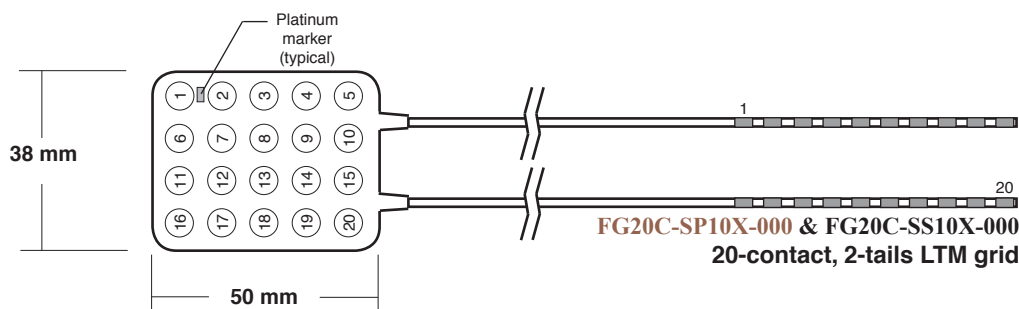

Electrodes are shown with the exposed contact surfaces facing DOWN.

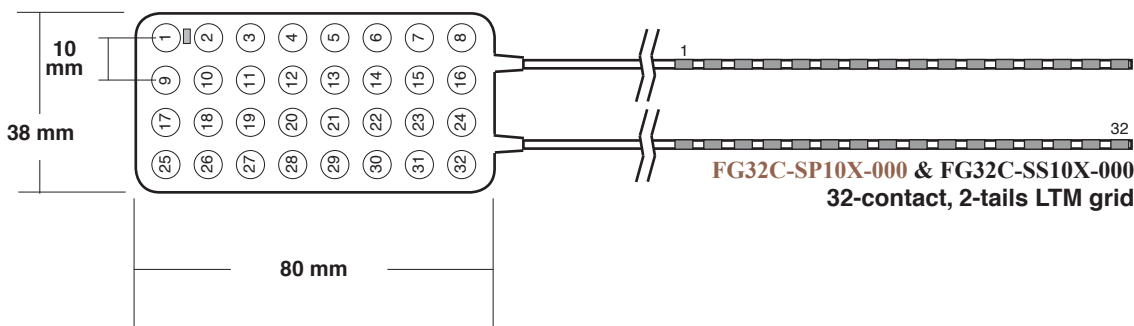

No. of Catalog Number	Contact Description ¹	Contacts	Material
FG08A-SP10X-000	2 x 4, 1-tail LTM grid	8	platinum
FG16A-SP10X-000	2 x 8, 1-tail LTM grid	16	platinum
FG20C-SP10X-000	4 x 5, 2-tails LTM grid	20	platinum
FG32C-SP10X-000	4 x 8, 2-tails LTM grid	32	platinum
FG16A-SS10X-000	2 x 8, 1-tail LTM grid	16	stainless
FG20C-SS10X-000	4 x 5, 2-tails LTM grid	20	stainless
FG32C-SS10X-000	4 x 8, 2-tails LTM grid	32	stainless

CABRIO® Cable
L-SRL-8DIN
L-SRL-16BDIN
L-SRL-20DIN
L-SRL-32BDIN
L-SRL-16BDIN
L-SRL-20DIN
L-SRL-32BDIN

RoTec™ Cable
L-RTL-8DIN
L-RTL-16BDIN
L-RTL-20DIN
L-RTL-32BDIN
L-RTL-16BDIN
L-RTL-20DIN
L-RTL-32BDIN

TECH-ATTACH® Cable	Components Block Qty
L-DCL-8DIN	DC-8X (1)
L-DCL-16BDIN	DC-16X (1)
L-DCL-20DIN	DC-10X (2)
L-DCL-32BDIN	DC-16X (2)
L-DCL-16BDIN	DC-16X (1)
L-DCL-20DIN	DC-10X (2)
L-DCL-32BDIN	DC-16X (2)

¹ Each electrode requires either the CABRIO, RoTec or the TECH-ATTACH cable and the quantity of individual connector blocks as indicated.

■ Manufactured in U.S.A. All dimensions are approximate. All drawings are not to scale. Consult price sheets for current pricing.

AD-TECH® EPILEPSY/LONG TERM MONITORING (LTM) SUBDURAL GRID ELECTRODES

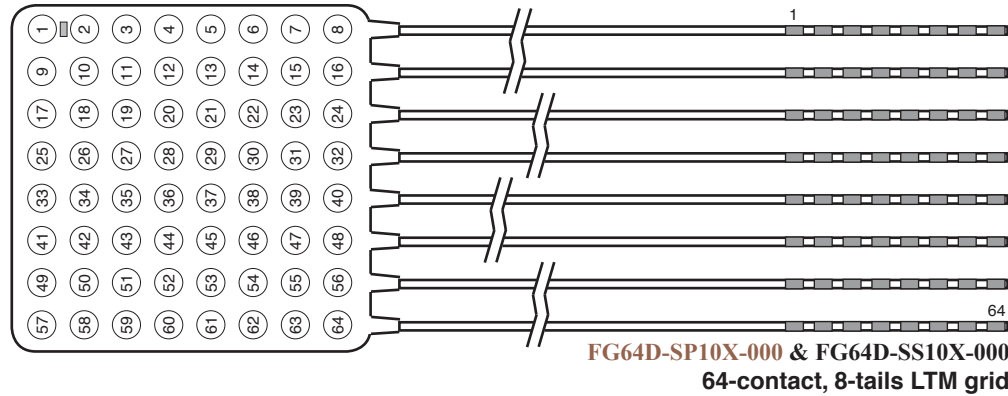
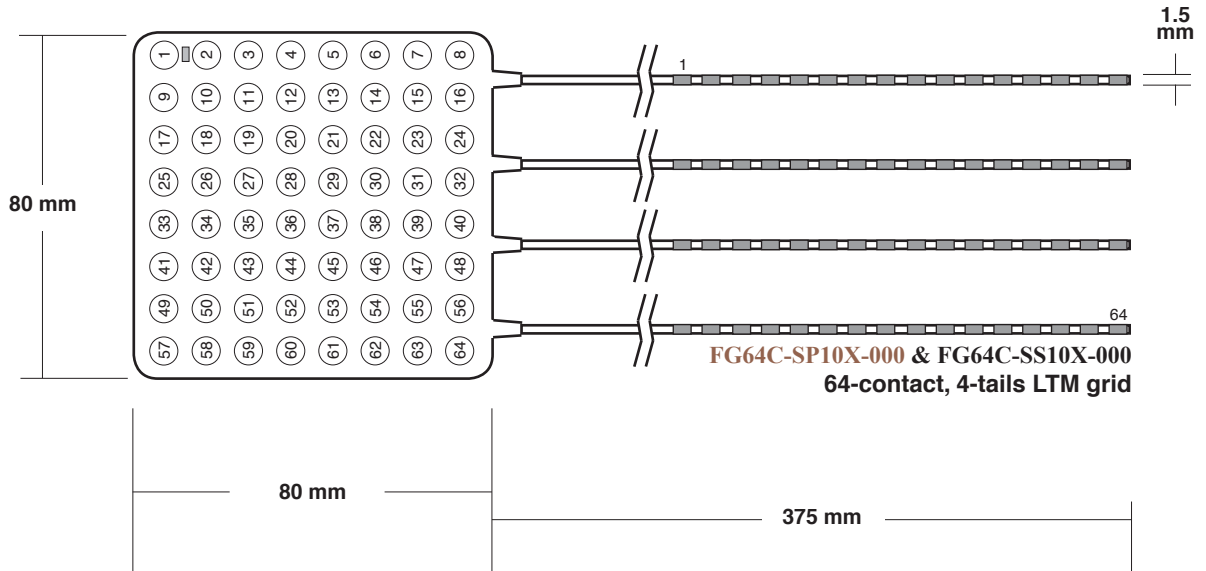
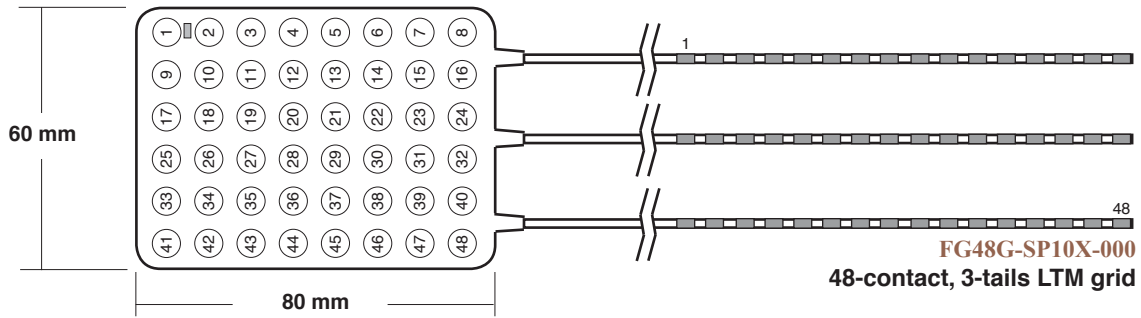

Electrodes are shown with the exposed contact surfaces facing DOWN.

No. of Catalog Number	Contact Description ¹	Contacts	Material	CABLE		TECH-ATTACH®	
				CABRIO® Cable	RoTec™ Cable	Cable	Components Block Qty
FG48G-SP10X-000	6 x 8, 3-tails LTM grid	48	platinum	L-SRL-48BDIN	L-RTL-48BDIN	L-DCL-48BDIN	DC-16X (3)
FG64C-SP10X-000	8 x 8, 4-tails LTM grid	64	platinum	L-SRL-64BDIN	L-RTL-64BDIN	L-DCL-64BDIN	DC-16X (4)
FG64D-SP10X-000	8 x 8, 8-tails LTM grid	64	platinum	L-SRL-64DIN	L-RTL-64DIN	L-DCL-64DIN	DC-8X (8)
FG64C-SS10X-000	8 x 8, 4-tails LTM grid	64	stainless	L-SRL-64BDIN	L-RTL-64BDIN	L-DCL-64BDIN	DC-16X (4)
FG64D-SS10X-000	8 x 8, 8-tails LTM grid	64	stainless	L-SRL-64DIN	L-RTL-64DIN	L-DCL-64DIN	DC-16X (8)

¹ Each electrode requires either the CABRIO, RoTec or the TECH-ATTACH cable and the quantity of individual connector blocks as indicated.

■ Manufactured in U.S.A. All dimensions are approximate. All drawings are not to scale. Consult price sheets for current pricing.



Telephone: 262.634.1555
Toll Free (USA): 800.776.1555

sales@adtechmedical.com
www.adtechmedical.com

AD-TECH® EPILEPSY/LTM TEMPORAL LOBE SUBDURAL GRID ELECTRODES

- Right and left electrodes are designed for the temporal and sub-temporal cortex
- Numbered, platinum contacts, 4.0 mm diameter with 2.3 mm exposure
- Sterile; single-use only

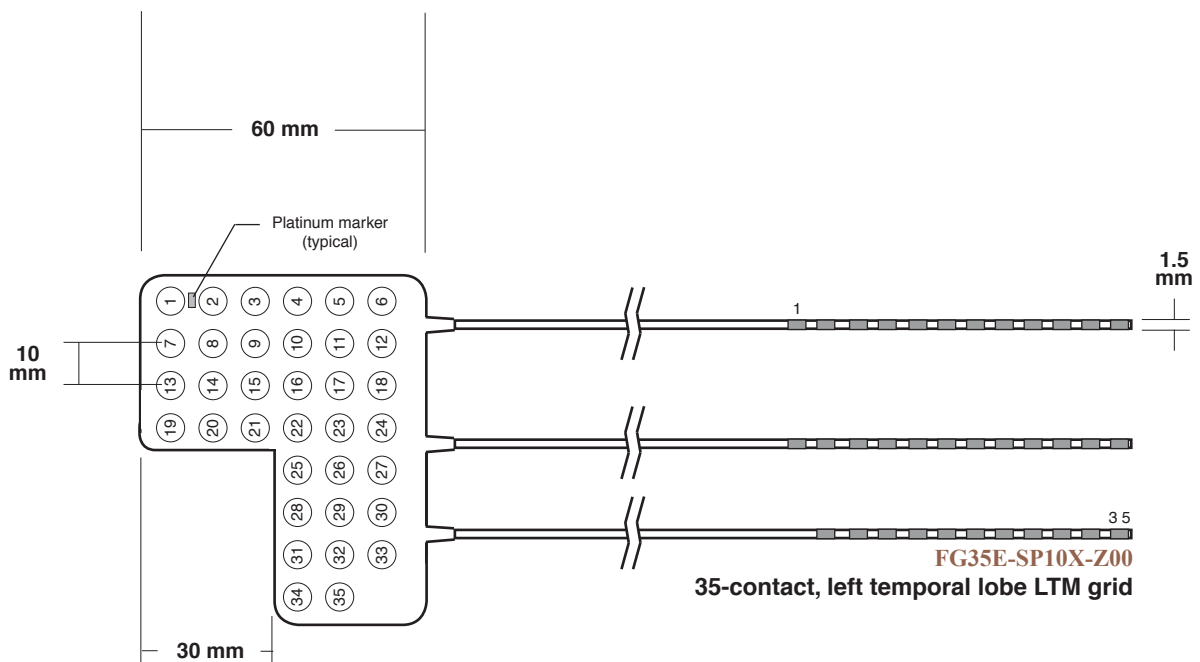
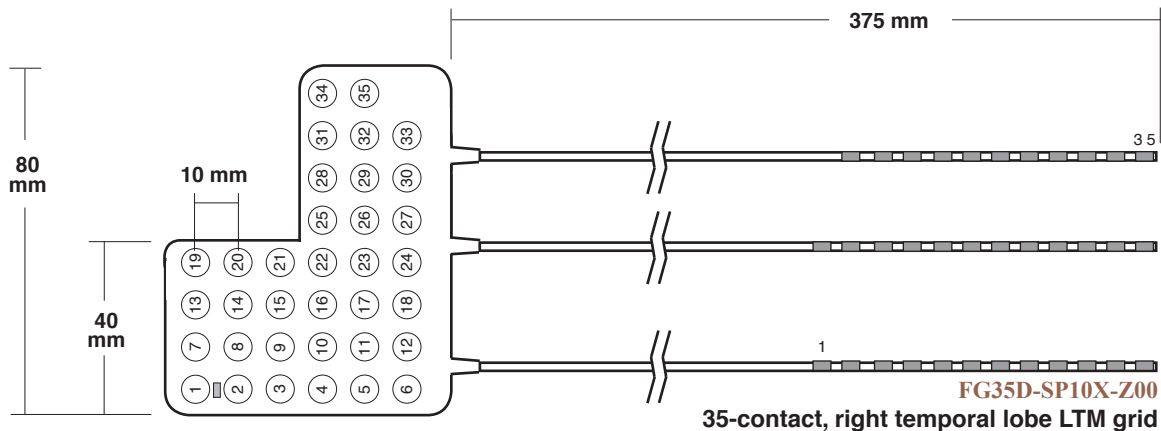

Electrodes are shown with the exposed contact surfaces facing DOWN.

Catalog Number	Description ¹	CABRIO® Cable	RoTec™ Cable	TECH-ATTACH® Cable	Components Block Qty
FG35D-SP10X-Z00	Right temporal lobe LTM grid	L-SRL-35DIN	L-RTL-35DIN	L-DCL-35DIN	DC-11X (1)
FG35E-SP10X-Z00	Left temporal lobe LTM grid				DC-12X (2)

¹ Each electrode requires either the CABRIO, RoTec, or the TECH-ATTACH cable and the quantity of individual connector blocks as indicated.

■ Manufactured in U.S.A. All dimensions are approximate. All drawings are not to scale. Consult price sheets for current pricing.

AD-TECH® EPILEPSY/LTM “L” & “T” SHAPED SUBDURAL STRIP & GRID ELECTRODES

- Numbered, platinum contacts with platinum markers as shown, 4.0 mm diameter with a 2.3 mm exposure
- “L” and “T” shapes offer you different tail-exit options
- 37.5 cm tail length
- Sterile; single-use only

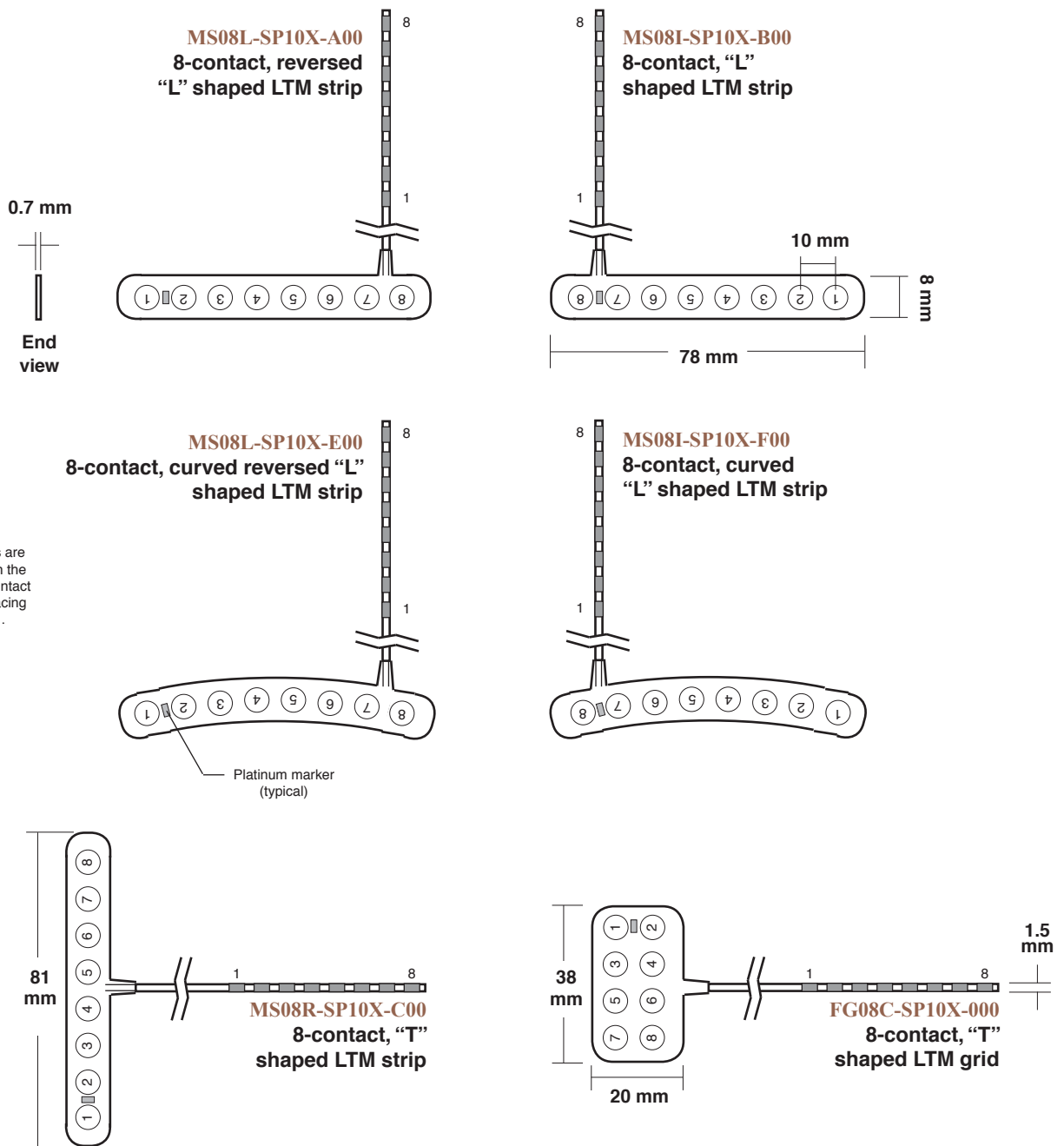

Catalog Number

MS08L-SP10X-A00
MS08I-SP10X-B00
MS08L-SP10X-E00
MS08I-SP10X-F00
MS08R-SP10X-C00
FG08C-SP10X-000

Description¹

Reversed “L” shaped LTM strip
“L” shaped LTM strip
Curved, reversed “L” LTM strip
Curved “L” shaped LTM strip
“T” shaped LTM strip
“T” shaped LTM grid

CABRIO® Cable	RoTec™ Cable	TECH-ATTACH® Cable	Components Block	Qty
L-SRL-8DIN	L-RTL-8DIN	L-DCL-8DIN	DC-8X	(1)

¹ Each electrode requires either the CABRIO, RoTec, or the TECH-ATTACH cable and the quantity of individual connector blocks as indicated.

■ Manufactured in U.S.A. All dimensions are approximate. All drawings are not to scale. Consult price sheets for current pricing.



Telephone: 262.634.1555
Toll Free (USA): 800.776.1555

sales@adtechmedical.com
www.adtechmedical.com

AD-TECH® EPILEPSY/LONG TERM MONITORING SUBDURAL STRIP ELECTRODES

- 8 mm width ■ Thin and flexible ■ Sterile; single-use only
- Platinum or stainless steel contacts, 4.0 mm diameter with a 2.3 mm exposure
- Non-numbered with reinforcement, designed for long-term monitoring applications

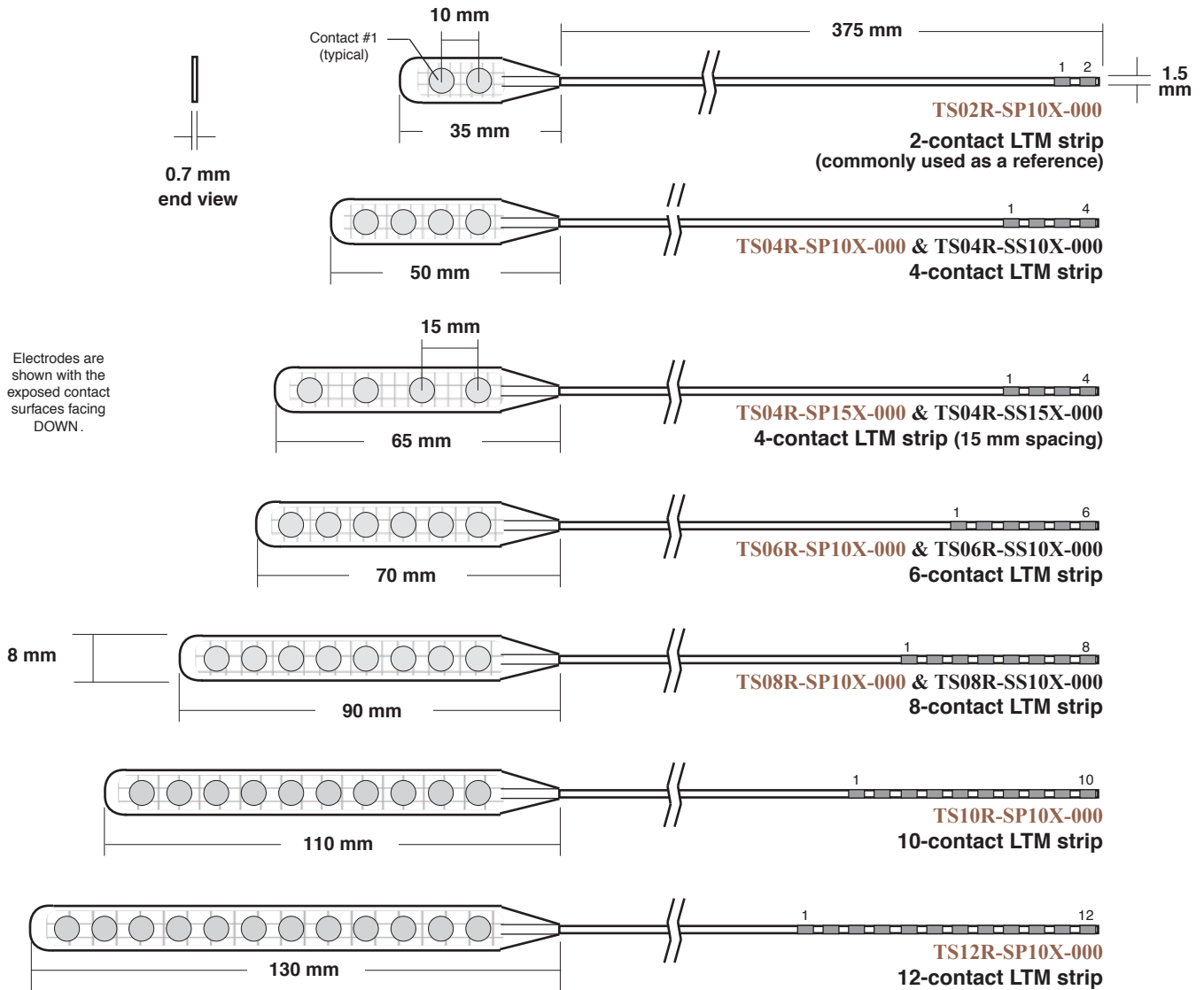

Catalog Number	Description ¹	Contact Material	Contact Spacing	CABRIO® Cable	RoTec® Cable	TECH-ATTACH® Cable	Components Block Qty
TS02R-SP10X-000	1 x 2 LTM strip	platinum	10	L-SRL-2DIN	L-RTL-2DIN	L-DCL-2DIN	DC-2X (1)
TS04R-SP10X-000	1 x 4 LTM strip	platinum	10	L-SRL-4DIN	L-RTL-4DIN	L-DCL-4DIN	DC-4X (1)
TS04R-SP15X-000	1 x 4 LTM strip	platinum	15	L-SRL-4DIN	L-RTL-4DIN	L-DCL-4DIN	DC-4X (1)
TS06R-SP10X-000	1 x 6 LTM strip	platinum	10	L-SRL-6DIN	L-RTL-6DIN	L-DCL-6DIN	DC-6X (1)
TS08R-SP10X-000	1 x 8 LTM strip	platinum	10	L-SRL-8DIN	L-RTL-8DIN	L-DCL-8DIN	DC-8X (1)
TS10R-SP10X-000	1 x 10 LTM strip	platinum	10	L-SRL-10DIN	L-RTL-10DIN	L-DCL-10DIN	DC-10X (1)
TS12R-SP10X-000	1 x 12 LTM strip	platinum	10	L-SRL-12BDIN	L-RTL-12BDIN	L-DCL-12BDIN	DC-12X (1)
TS04R-SS10X-000	1 x 4 LTM strip	stainless	10	L-SRL-4DIN	L-RTL-4DIN	L-DCL-4DIN	DC-4X (1)
TS04R-SS15X-000	1 x 4 LTM strip	stainless	15	L-SRL-4DIN	L-RTL-4DIN	L-DCL-4DIN	DC-4X (1)
TS06R-SS10X-000	1 x 6 LTM strip	stainless	10	L-SRL-6DIN	L-RTL-6DIN	L-DCL-6DIN	DC-6X (1)
TS08R-SS10X-000	1 x 8 LTM strip	stainless	10	L-SRL-8DIN	L-RTL-8DIN	L-DCL-8DIN	DC-8X (1)

¹ Each electrode requires either the CABRIO, RoTec or the TECH-ATTACH cable and the quantity of individual connector blocks as indicated.

■ Manufactured in U.S.A. All dimensions are approximate. All drawings are not to scale. Consult price sheets for current pricing.

AD-TECH® EPILEPSY/LTM NARROW-BODY SUBDURAL STRIP ELECTRODES

- 4.0 mm contact diameter with reduced contact exposure (1.8 mm), may aid during electrode removal
- Non-numbered with reinforcement, designed for long-term monitoring applications
- Platinum contacts ■ Thin and flexible ■ Sterile; single-use only ■ 6 mm width

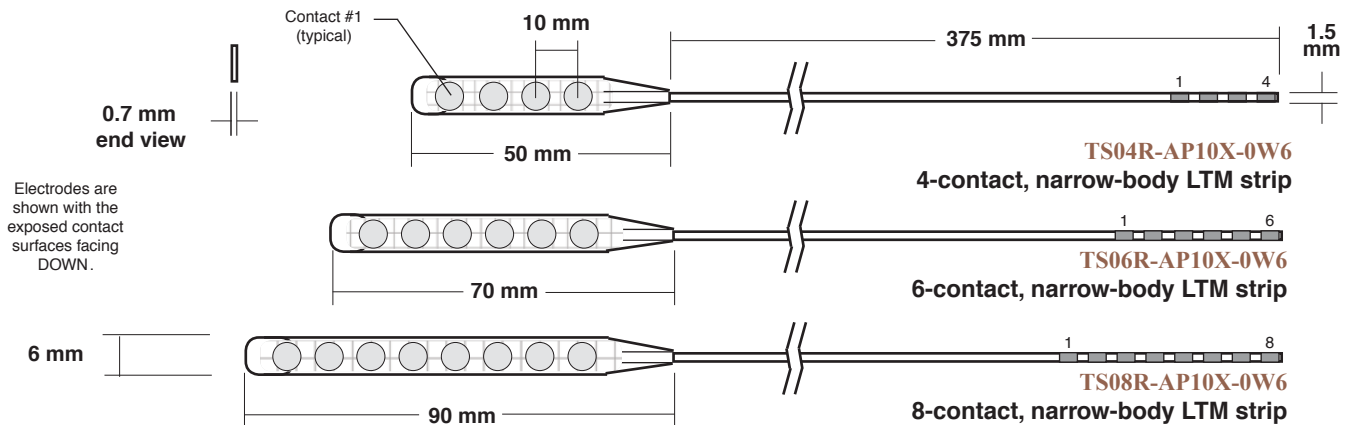

Catalog Number	Description ¹
TS04R-AP10X-0W6	1 x 4 narrow-body strip
TS06R-AP10X-0W6	1 x 6 narrow-body strip
TS08R-AP10X-0W6	1 x 8 narrow-body strip

CABRIO® Cable
L-SRL-4DIN
L-SRL-6DIN
L-SRL-8DIN

RoTec™ Cable
L-RTL-4DIN
L-RTL-6DIN
L-RTL-6DIN

TECH-ATTACH® Cable	Components Block	Qty
L-DCL-4DIN	DC-4X	(1)
L-DCL-6DIN	DC-6X	(1)
L-DCL-8DIN	DC-8X	(1)

AD-TECH® EPILEPSY/LTM 3D STYLE SUBDURAL STRIP ELECTRODES

- Large, indented 6.0 mm diameter contacts with 4.0 mm diameter exposed recording area
- Numbered, platinum contacts

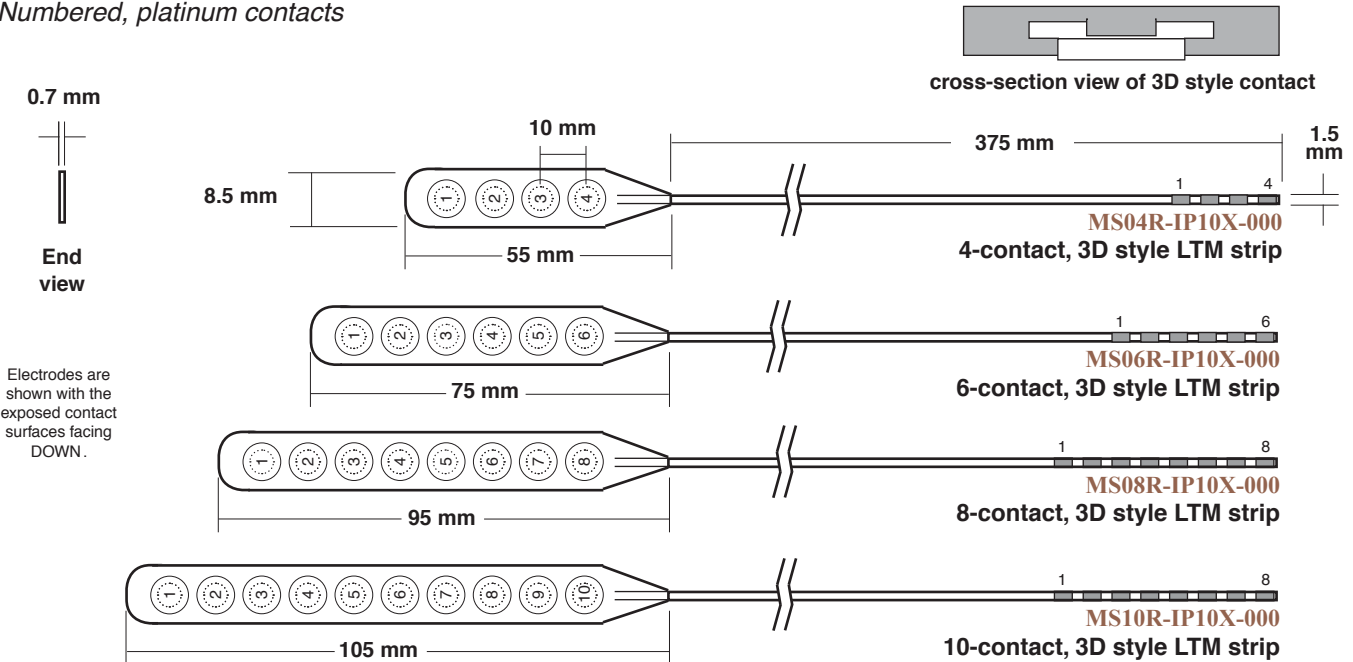

Catalog Number	Description ¹
MS04R-IP10X-000	1 x 4 large, 3D style strip
MS06R-IP10X-000	1 x 6 large, 3D style strip
MS08R-IP10X-000	1 x 8 large, 3D style strip
MS10R-IP10X-000	1 x 10 large, 3D style strip

CABRIO® Cable
L-SRL-4DIN
L-SRL-6DIN
L-SRL-8DIN
L-SRL-10DIN

RoTec™ Cable
L-RTL-4DIN
L-RTL-6DIN
L-RTL-8DIN
L-RTL-10DIN

TECH-ATTACH® Cable	Components Block	Qty
L-DCL-4DIN	DC-4X	(1)
L-DCL-6DIN	DC-6X	(1)
L-DCL-8DIN	DC-8X	(1)
L-DCL-10DIN	DC-10X	(1)

¹ Each electrode requires either the CABRIO, RoTec or the TECH-ATTACH cable and the quantity of individual connector blocks as indicated.

■ Manufactured in U.S.A. All dimensions are approximate. All drawings are not to scale. Consult price sheets for current pricing.



AD-TECH® MACRO/MICRO STRIP ELECTRODES

- Manufactured with 50 or 38 Micron Platinum irridium wire
- 4.0mm contact diameter
- Numbered Platinum contacts ■ Thin and flexible ■ Sterile; single-use only ■ 8 mm width
- Contact your Ad-Tech Representative for alternative designs or other special requirements
- Used with single tail passing needles
- 37.5 cm tail length

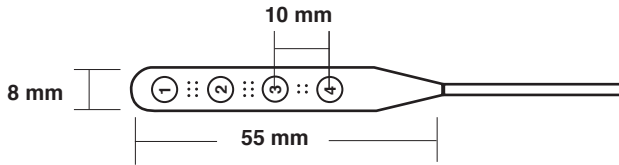

QG20C-SP10X-000
20-contact, macro-micro strip

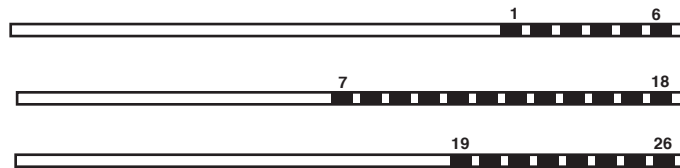
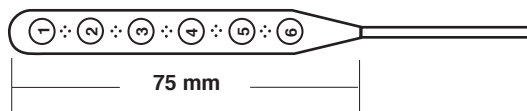
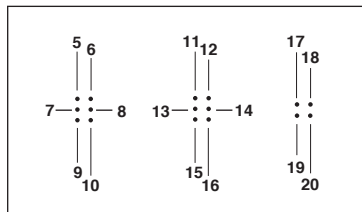

QG26A-SP10X-000
26-contact, macro-micro strip

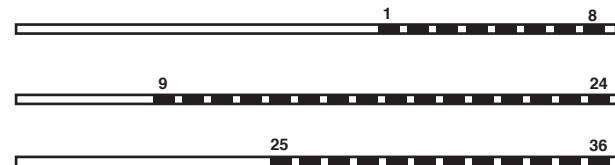
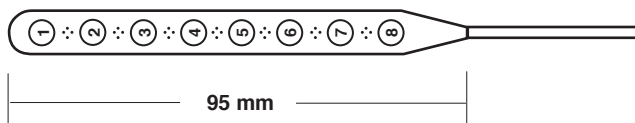
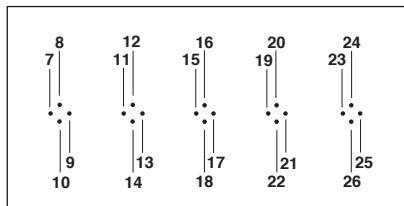

QG36B-SP10X-000
36-contact, macro-micro strip

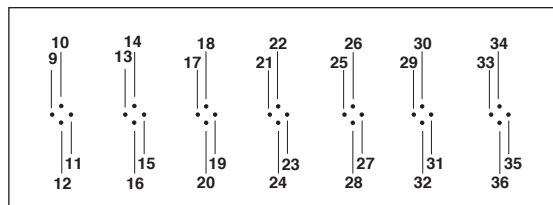

Catalog Number ¹	Description
QG20C-SP10X-000	20 contact macro-micro strip, 4 macro, 16 micro
QG26A-SP10X-000	26 contact macro-micro strip, 6 macro, 20 micro
QG36B-SP10X-000	36 contact macro-micro strip, 8 macro, 28 micro

Macro Tail Cables ²
L-SRL-4DIN, L-RTL-4DIN or L-DCL-4DIN
L-SRL-6DIN, L-RTL-6DIN or L-DCL-6DIN
L-SRL-8DIN, L-RTL-8DIN or L-DCL-8DIN

Many cable options are available for the micro recording tails. Contact your Ad-Tech representative to discuss these options.

■ Manufactured in U.S.A. All dimensions are approximate. All drawings are not to scale. Consult price sheets for current pricing.
 1 - 38.1 Micron
 2 - Tech-Attach cables require appropriate connector block

AD-TECH® EPILEPSY/LTM DUAL-SIDED INTERHEMISPHERIC SUBDURAL ELECTRODES

- Mirror-imaged contacts on both sides of the electrode
- Platinum & number markers as shown
- Sterile; single-use only
- Platinum contacts, 4.0 mm diameter with a 2.3 mm exposure

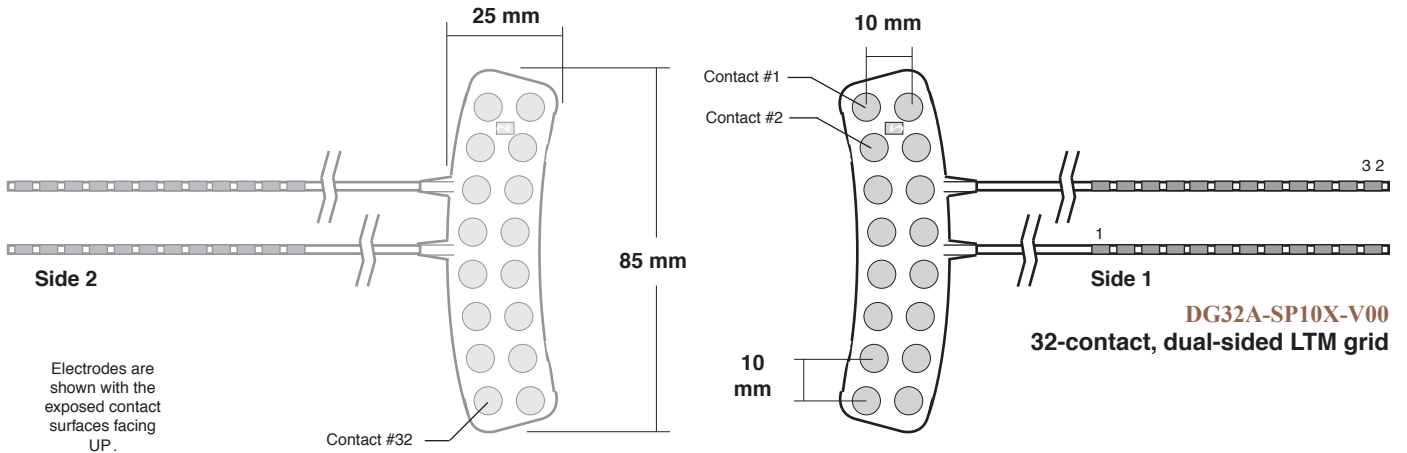
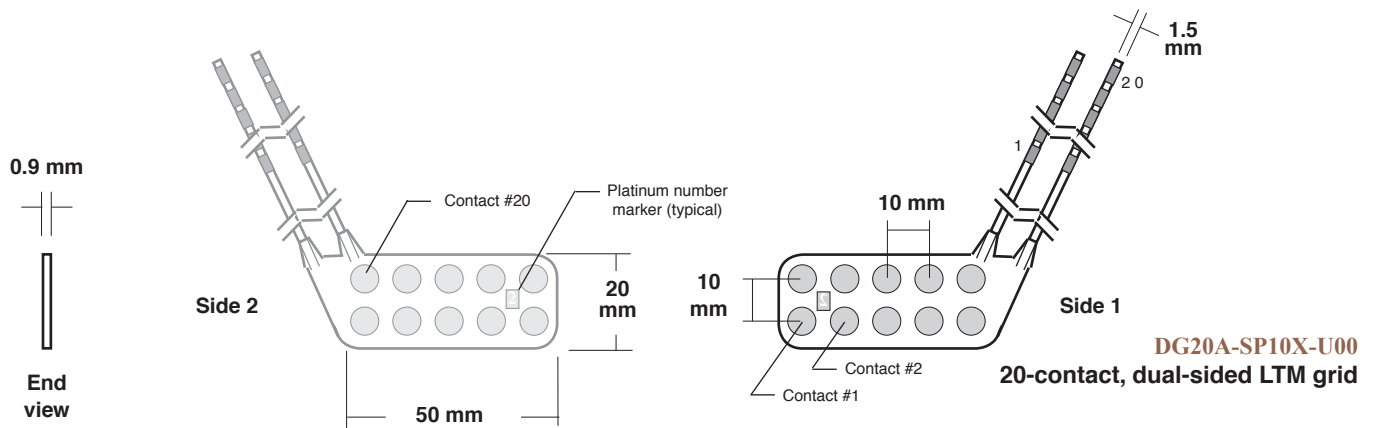
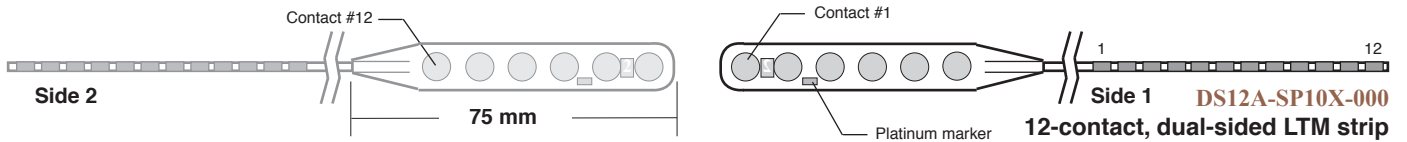
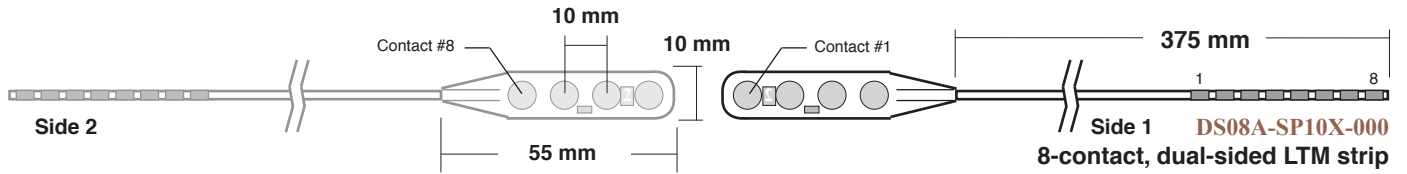

Catalog Number	Description ¹	CABRIO® Cable		RoTec™ Cable		TECH-ATTACH® Cable		Components	
								Block	Qty
DS08A-SP10X-000	1 x 4 dual	L-SRL-8DIN	L-SRL-8BDIN	L-RTL-8DIN	L-RTL-8BDIN	L-DCL-8DIN	DC-8X	(1)	
DS12A-SP10X-000	1 x 6 dual	L-SRL-12BDIN	L-SRL-12BDIN	L-RTL-12BDIN	L-RTL-12BDIN	L-DCL-12BDIN	DC-12X	(1)	
DG20A-SP10X-U00	2 x 5 angled, dual	L-SRL-20DIN	L-SRL-20DIN	L-RTL-20DIN	L-RTL-20DIN	L-DCL-20DIN	DC-10X	(2)	
DG32A-SP10X-V00	2 x 8 curved, dual	L-SRL-32BDIN	L-SRL-32BDIN	L-RTL-32BDIN	L-RTL-32BDIN	L-DCL-32BDIN	DC-16X	(2)	

¹ Each electrode requires either the CABRIO, RoTec, or the TECH-ATTACH cable and the quantity of individual connector blocks as indicated.

■ Manufactured in U.S.A. All dimensions are approximate. All drawings are not to scale. Consult price sheets for current pricing.

AD-TECH® INTRAOPERATIVE MONITORING (IOM) SUBDURAL STRIP ELECTRODES

- Intraoperative monitoring electrodes feature numbered contacts, greater visibility of the recording surface and greater flexibility of the electrode contact area
- Platinum or stainless steel numbered contacts, 4.0 mm diameter with a 2.3 mm exposure
- Sterile; single-use only

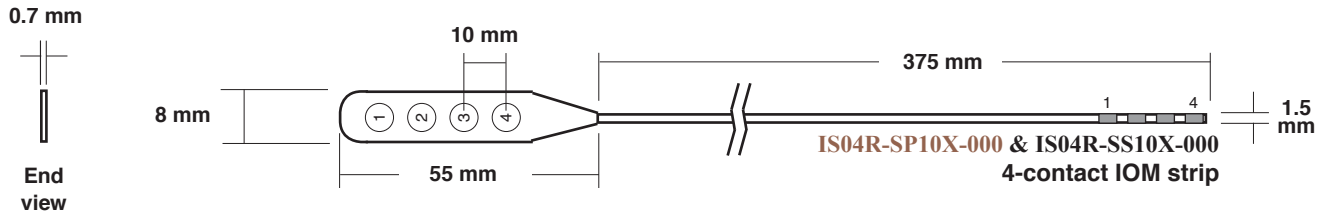

Electrodes are shown with the exposed contact surfaces facing DOWN.

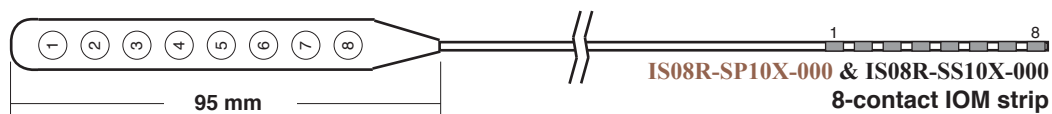
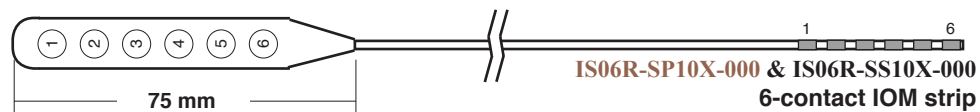

Catalog Number	Description ¹	Contact Material	Cable		TECH-ATTACH [®] Components		
			CABRIO [®] Cable	RoTec [™] Cable	Cable	Block	Qty
IS04R-SP10X-000	1 x 4 IOM strip	platinum	L-SRL-4DIN	L-RTL-4DIN	L-DCL-4DIN	DC-4X	(1)
IS06R-SP10X-000	1 x 6 IOM strip	platinum	L-SRL-6DIN	L-RTL-6DIN	L-DCL-6DIN	DC-6X	(1)
IS08R-SP10X-000	1 x 8 IOM strip	platinum	L-SRL-8DIN	L-RTL-8DIN	L-DCL-8DIN	DC-8X	(1)
IS04R-SS10X-000	1 x 4 IOM strip	stainless	L-SRL-4DIN	L-RTL-4DIN	L-DCL-4DIN	DC-4X	(1)
IS06R-SS10X-000	1 x 6 IOM strip	stainless	L-SRL-6DIN	L-RTL-6DIN	L-DCL-6DIN	DC-6X	(1)
IS08R-SS10X-000	1 x 8 IOM strip	stainless	L-SRL-8DIN	L-RTL-8DIN	L-DCL-8DIN	DC-8X	(1)

¹ Each electrode requires either the CABRIO, RoTec or the TECH-ATTACH cable and the quantity of individual connector blocks as indicated.

■ Manufactured in U.S.A. All dimensions are approximate. All drawings are not to scale. Consult price sheets for current pricing.

AD-TECH® IOM ELECTRODES WITH ATTACHED CABLES

- 6mm platinum or stainless steel indented contacts, 4 mm exposure, with 1.8 m attached cable
- Sterile; single-use only
- One-piece, easy to use

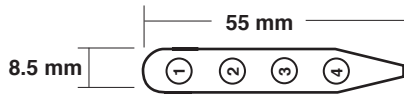

MS04N-IS10X-0JF **MS04N-IP10X-0JF**
4-contact, IOM strip with attached cable

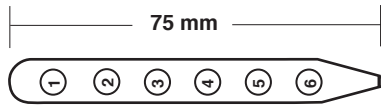
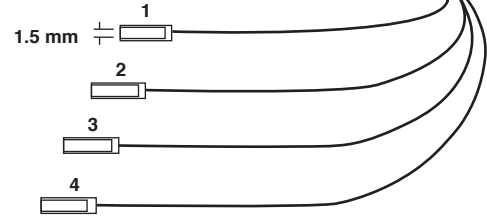

MS06N-IS10X-0JF **MS06N-IP10X-0JF**
6-contact, IOM strip with attached cable

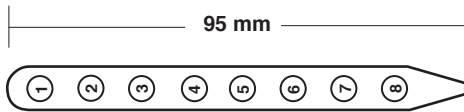
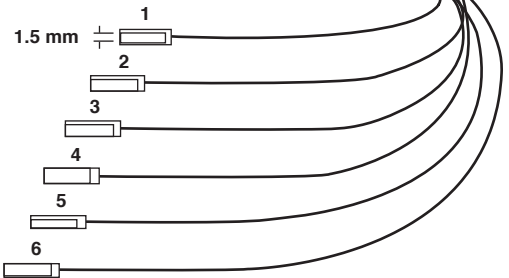

MS08N-IS10X-0JF **MS08N-IP10X-0JF**
8-contact, IOM strip with attached cable

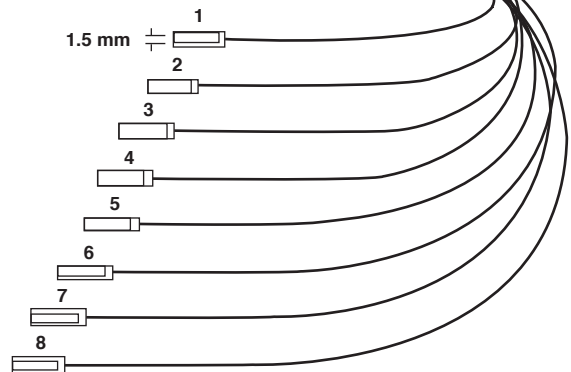

cross-section view of 3D style contact

Connection Method
 1.5 mm safety socket

Catalog Number	Description
MS04N-IP10X-0JF	1 x 4 large, 3D style platinum strip with attached cable
MS06N-IP10X-0JF	1 x 6 large, 3D style platinum strip with attached cable
MS08N-IP10X-0JF	1 x 8 large, 3D style platinum strip with attached cable
FG08N-IP10X-0JF	2 x 4 large, 3D style platinum grid with attached cable
MS04N-IS10X-0JF	1 x 4 large, 3D style stainless steel strip with attached cable
MS06N-IS10X-0JF	1 x 6 large, 3D style stainless steel strip with attached cable
MS08N-IS10X-0JF	1 x 8 large, 3D style stainless steel strip with attached cable
FG08N-IS10X-0JF	2 x 4 large, 3D style stainless steel grid with attached cable

AD-TECH® INTRAOPERATIVE MAPPING ELECTRODE SYSTEM

- The intraoperative mapping electrode system provides an alternative design for intraoperative monitoring
- Clover-leaf electrode stabilizes the electrode contact on the brain
- Stainless steel numbered contacts, 6.0 mm diameter with 4.0 mm exposure, 3D style
- Sterile; single-use only

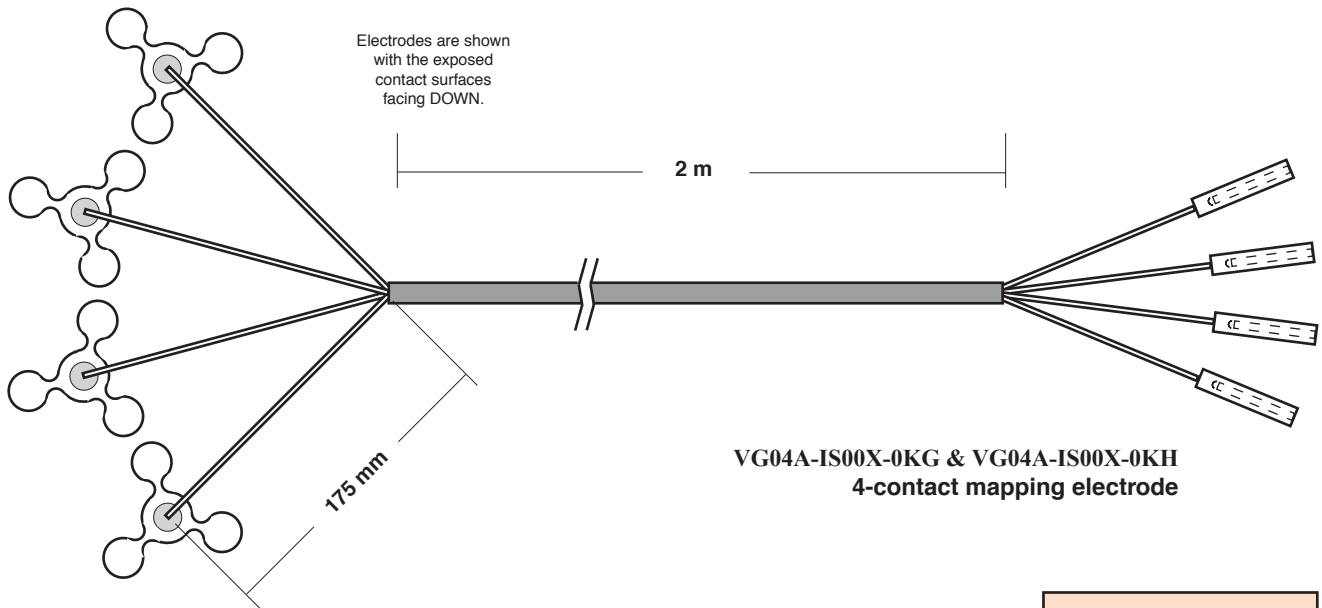

Catalog Number	Description
VG04A-IS00X-0KG	4-contact mapping electrode, numbered 1 - 4
VG04A-IS00X-0KH	4-contact mapping electrode, numbered 5 - 8

Connection Method¹
1.5 mm safety socket

- VG-series electrodes do not require any additional cabling to interface with standard EP monitoring equipment.
- Manufactured in U.S.A. All dimensions are approximate. All drawings are not to scale. Consult price sheets for current pricing.

AD-TECH® EPIDURAL SPINAL ELECTRODES

- For intraoperative monitoring of evoked potential (EPs) of the descending pathway during spinal surgery
- 2 or 3 platinum contacts
- Sterile; single-use only
- 16 gauge tuohy needle 0.044 inch/1.1176 mm in diameter
- CEDL-Series electrodes do not require any additional cabling, 1.5 mm safety sockets attached
- Attached 2 meter cable

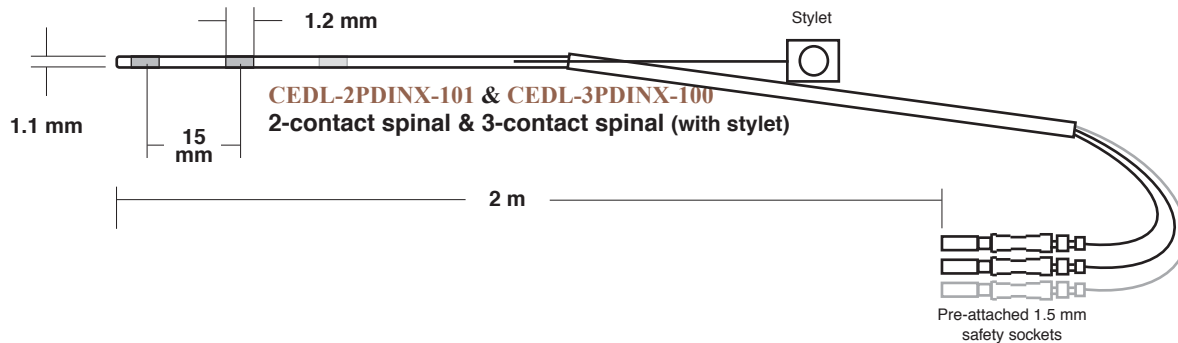

Catalog Number	Block	Placement Qty
¹ CEDL-2PDINX-101	2-contact spinal electrode w/ pre-attached lead	16 ga. Tuohy Needle + stylet
CEDL-3PDINX-100	3-contact spinal electrode w/ pre-attached lead	16 ga. Tuohy Needle + stylet

Connection Method¹
1.5 mm safety socket

¹20 dots 10 mm apart beginning 10 mm from #2 center. 100 mm mark should be a ring

AD-TECH® EPILEPSY/LTM MACRO-MICRO DEPTH ELECTRODES

- For simultaneous macro and micro recordings of the deep brain structures.
- Sterile; single-use only
- Platinum contacts

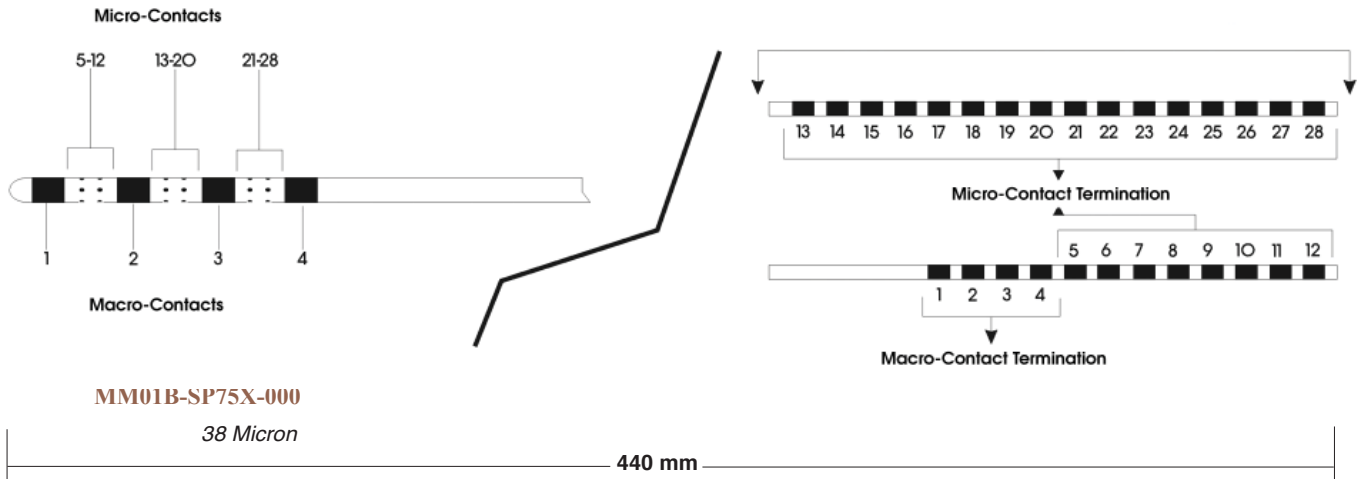
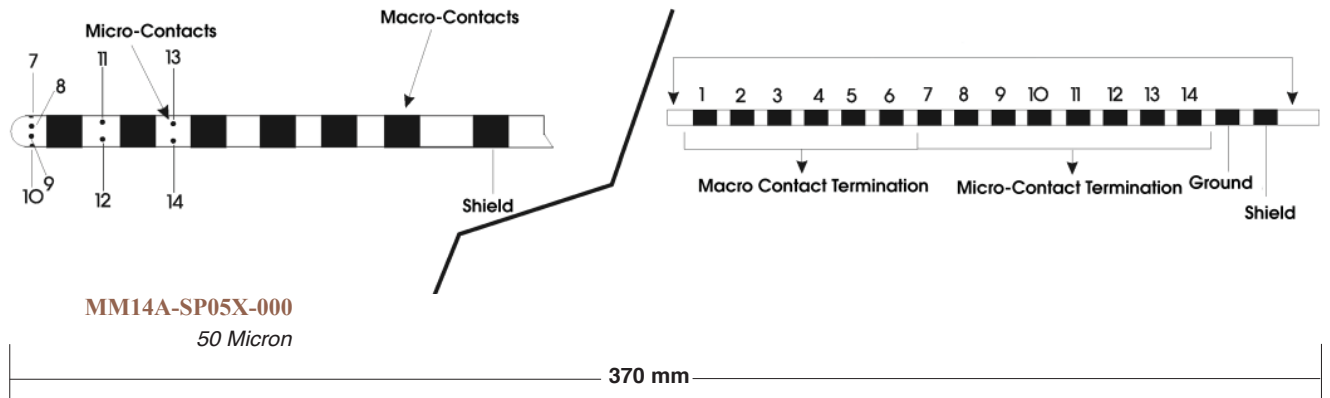
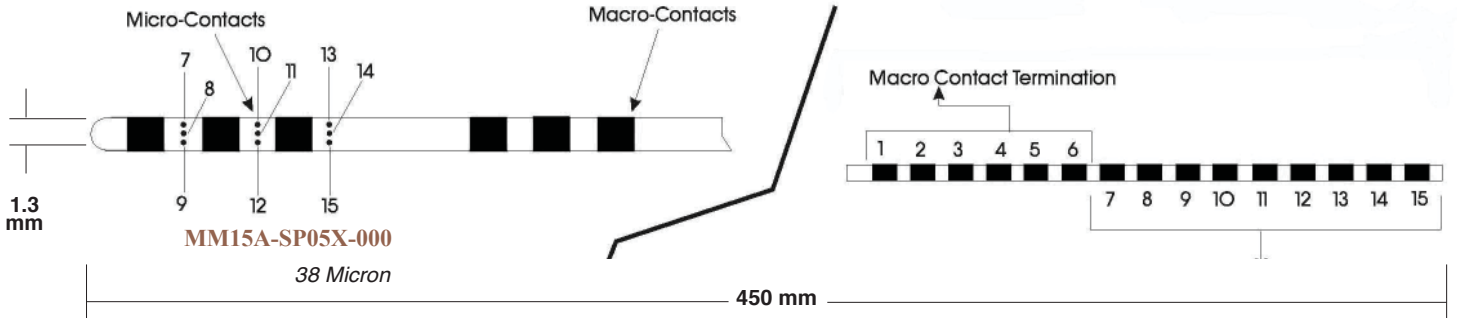

Catalog Number	Description	No. of Macro Contacts	No. of Micro Contacts
MM15A-SP05X-000	Kawasaki Macro-Micro Amygdala	6	9
MM14A-SP05X-000	14 contact Macro-Micro depth	6	8
MM01B-SP75X-000	28 contact Macro-Micro depth	4	24

Many cable options are available for the micro recording tails. Contact your Ad-Tech representative to discuss these options.

- Contact your Ad-Tech rep for product details, alternative designs, and connection information.
- Manufactured in U.S.A. All dimensions are approximate. All drawings are not to scale. Consult price sheets for current pricing.



Telephone: 262.634.1555
Toll Free (USA): 800.776.1555

sales@adtechmedical.com
www.adtechmedical.com

AD-TECH® EPILEPSY/LTM BEHNKE FRIED DEPTH ELECTRODES

- For simultaneous macro and micro contact recordings
- 8-contact macro recording outer body with 8-contact micro recording inner wire bundle
- Platinum contacts
- Sterile; single-use only

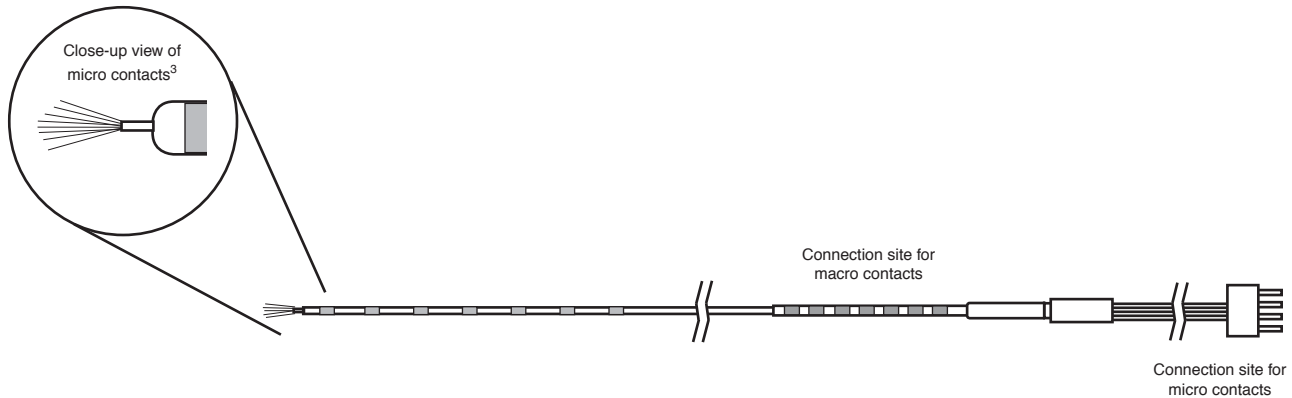
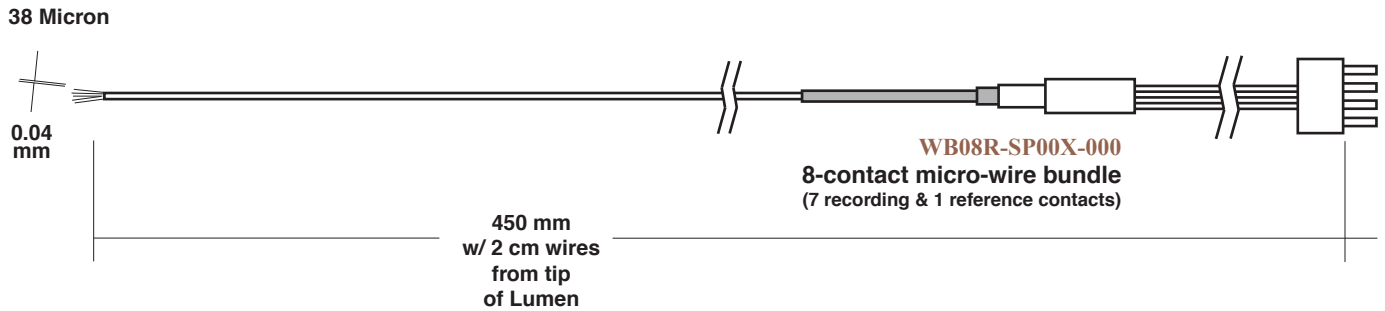
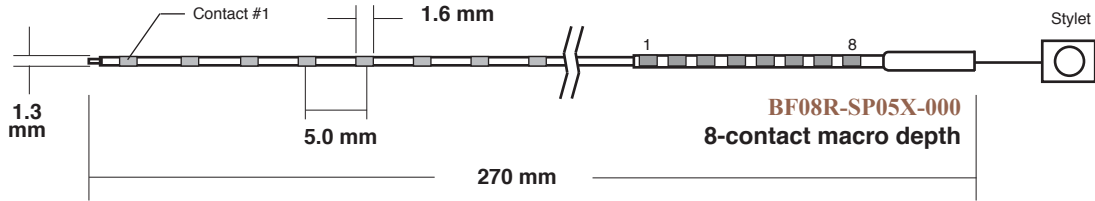

Macro-Micro Electrode Shown Assembled

Catalog Number	Description ¹	Contact Size ²	Contact Spacing	TECH-ATTACH® Components	
				Cable	Block
BF08R-SP05X-000	8-contact macro-depth	1.6/1.3	5.0 mm	L-DCL-8DIN	included
WB08R-SP00X-000	8-contact micro-depth (7 recording & 1 reference)	0.04 dia.	N/A	CLW-8DIN-26 ⁴	

¹ Each electrode requires the TECH-ATTACH or wire bundle cable as indicated. A special, slotted connector block that connects the macro contacts to the TECH-ATTACH cable is included with each BF-series electrode.

² Overall length of the contact followed by its diameter (mm).

³ Micro wires extend 2 cm past the tip; trim to desired length prior to use.

⁴ Cable is 6 feet long and terminates in 1.5 mm safety socket.

■ Manufactured in U.S.A. All dimensions are approximate. All drawings are not to scale. Consult price sheets for current pricing.

AD-TECH® EPILEPSY/LTM FORAMEN OVALE ELECTRODES

- For lateralizing/localizing the epileptic foci for the surgical treatment of epilepsy
- One-piece body construction
- 1.0 mm body diameter
- Sterile; single-use only
- Includes two 17 gauge (0.04 inch/1.016 mm) needles for placement
- Uses FO-style TECH-ATTACH connection systems
- 2.4 mm long, platinum contacts

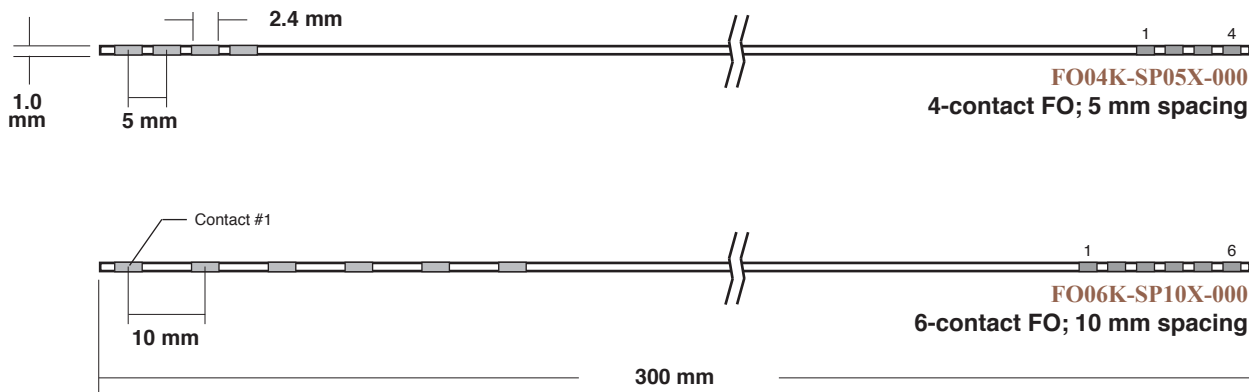

Catalog Number	Description ¹
FO04K-SP05X-000	4-contact FO set
FO06K-SP10X-000	6-contact FO set

TECH-ATTACH® Components	
Cable	Block
FO-LDC-4DIN	included
FO-LDC-6DIN	included

- Stainless steel contacts
- 0.50 mm body diameter
- 2.0 mm long contacts
- Requires crimping of pins to electrode wire after placement
- Sterile; single-use only
- Each set requires leadwire set

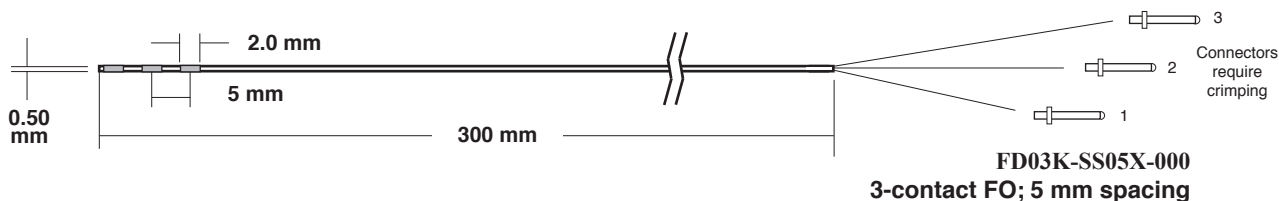

Catalog Number	Description ¹	Connectors	
		Cable	Crimper
FD03K-SS05X-000	3-contact FO set, with 5mm contact spacing and introducing needles	L-3-FODIN	712-N
712-N	Crimping tool. Used with all sphenoidal electrode kit or sets and/or with all foramen ovale electrodes with <i>non-crimped</i> connectors.		

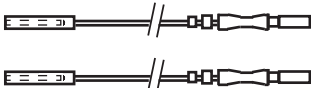
- 711-LWKDINX  Lead wire set. 6 feet (1.8 m) long. Includes one orange and one yellow wire. 1.5 mm safety sockets. Sterile; single-use only.

¹ Each FO-series electrode set includes two foramen ovale electrodes, two 17 gauge (0.04 inch/1.016 mm diameter) introducing needles and two TECH-ATTACH connector blocks. Each set requires the cable indicated. Sterile; single-use only.
The FD03K-SS05X-000 electrode set includes two foramen ovale electrodes, eight pin connectors, two 18 gauge (0.036 inch/0.9144 mm diameter), introducing needles and two 19 gauge (0.03 inch/0.962 mm diameter) introducing needles. It requires the cable and crimper indicated.

■ Manufactured in U.S.A. All dimensions are approximate. All drawings are not to scale. Consult price sheets for current pricing.



AD-TECH® EPILEPSY/LTM SPENCER® PROBE DEPTH ELECTRODES

- For monitoring/mapping subsurface levels of the brain during the surgical treatment of epilepsy
- One-piece body construction ■ Colored band ■ Numbered label and 19 cm marker
- Platinum contacts ■ Stay flange ■ Sterile; single-use only

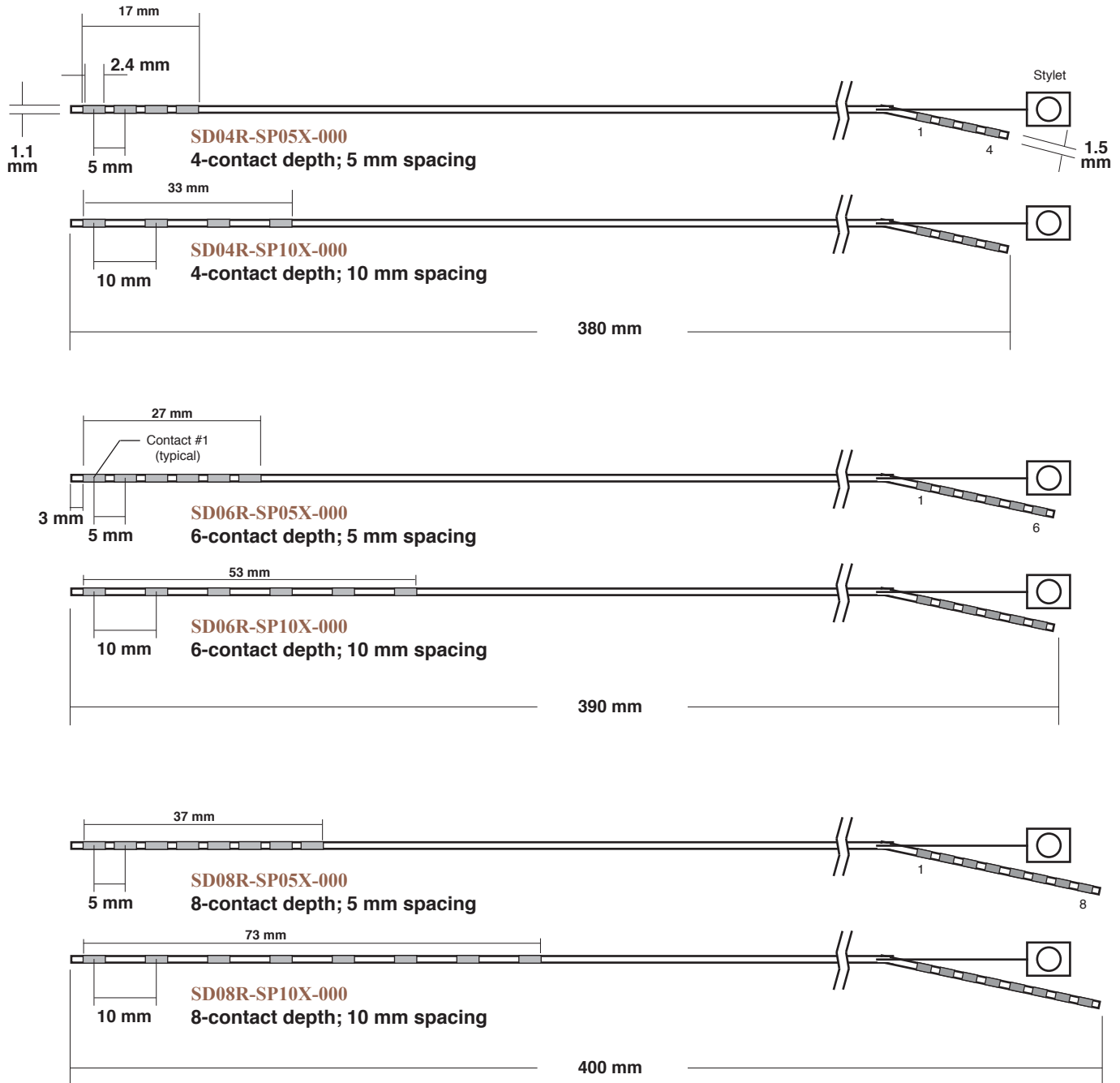

Contact Catalog Number	Description ¹	Size ²	Body Diameter	Contact Spacing	CABRIO® Cable	RoTec™ Cable	TECH-ATTACH® Cable	Components Block	Qty
SD04R-SP05X-000	4-contact depth	2.4/1.1	1.1	5	L-SRL-4DIN	L-RTL-4DIN	L-DCL-4DIN	DC-4X	(1)
SD04R-SP10X-000	4-contact depth	2.4/1.1	1.1	10	L-SRL-4DIN	L-RTL-4DIN	L-DCL-4DIN	DC-4X	(1)
SD06R-SP05X-000	6-contact depth	2.4/1.1	1.1	5	L-SRL-6DIN	L-RTL-6DIN	L-DCL-6DIN	DC-6X	(1)
SD06R-SP10X-000	6-contact depth	2.4/1.1	1.1	10	L-SRL-6DIN	L-RTL-6DIN	L-DCL-6DIN	DC-6X	(1)
SD08R-SP05X-000	8-contact depth	2.4/1.1	1.1	5	L-SRL-8DIN	L-RTL-8DIN	L-DCL-8DIN	DC-8X	(1)
SD08R-SP10X-000	8-contact depth	2.4/1.1	1.1	10	L-SRL-8DIN	L-RTL-8DIN	L-DCL-8DIN	DC-8X	(1)

¹ Each electrode requires either the CABRIO, RoTec or the TECH-ATTACH cable and the quantity of individual connector blocks as indicated.

² Overall length of the contact followed by its diameter (mm).

■ Manufactured in U.S.A. All dimensions are approximate. All drawings are not to scale. Consult price sheets for current pricing.

AD-TECH® EPILEPSY/LTM SPENCER® PROBE DEPTH ELECTRODES

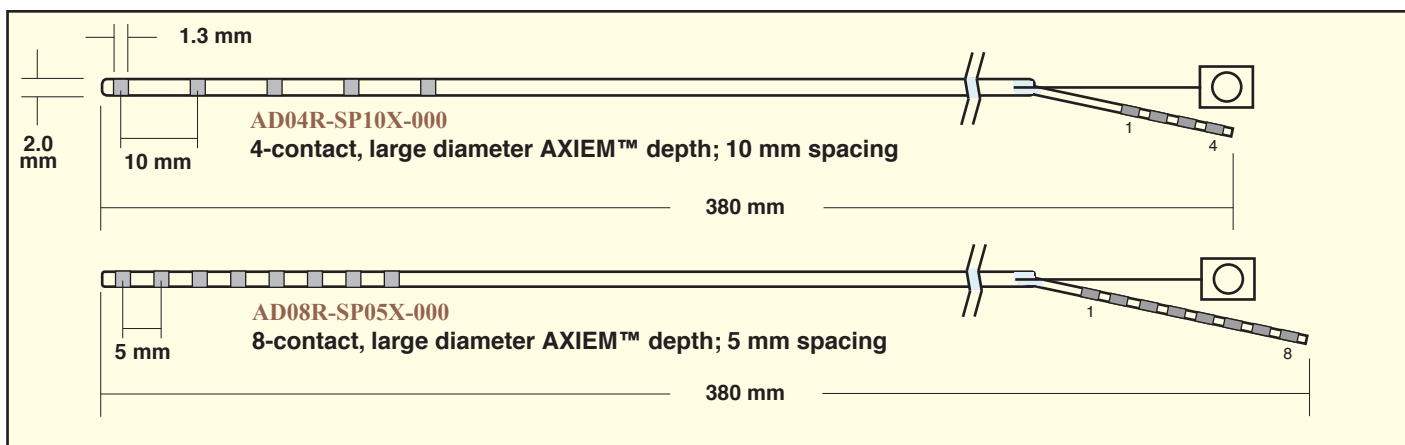
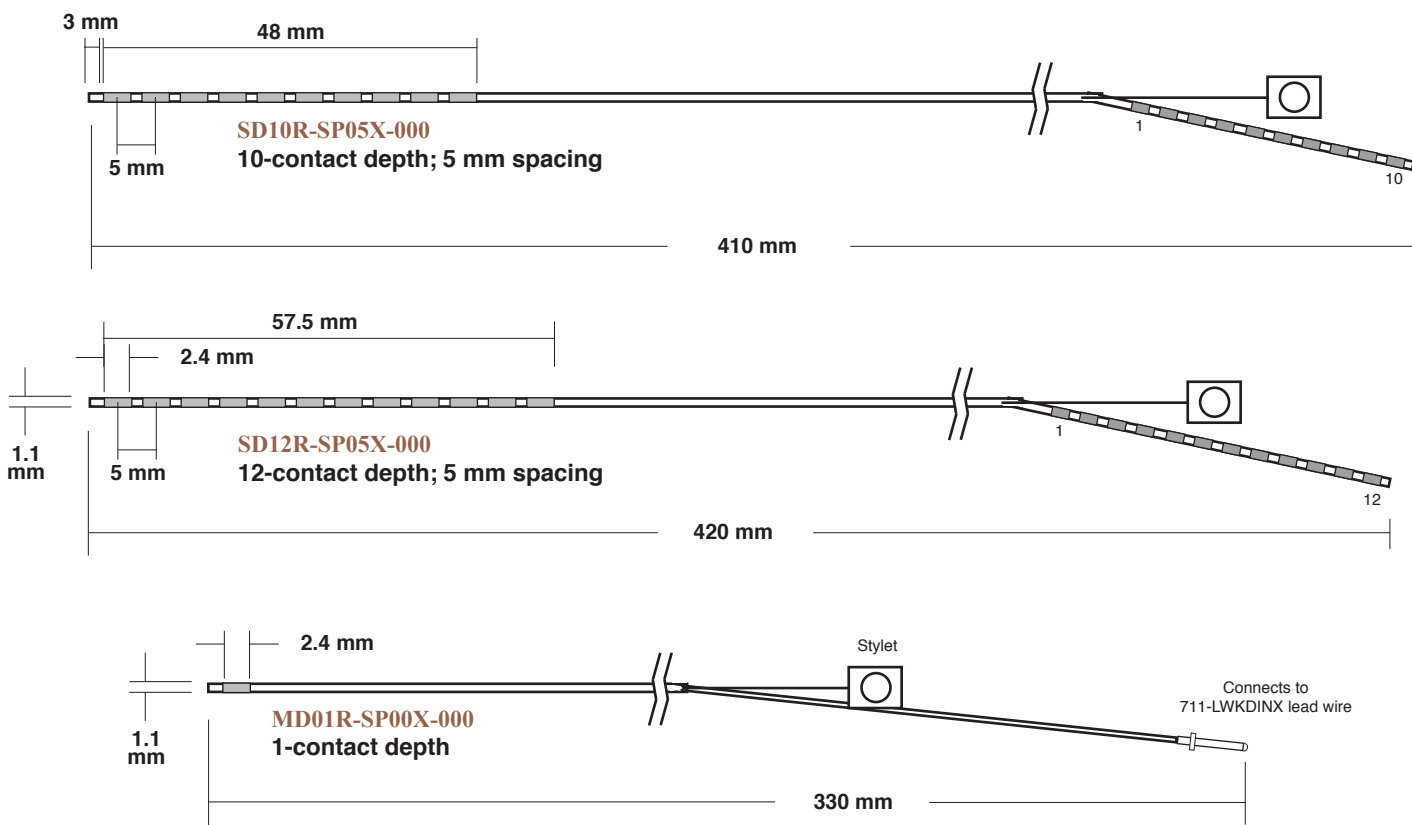

Catalog Number ¹	Description	Contact Size ²	Body Diameter	Contact Spacing	CABRIO® Cable	RoTec™ Cable	TECH-ATTACH® Components	
							Cable	Block Qty
SD10R-SP05X-000	10-contact depth	2.4/1.1	1.1	5	L-SRL-10DIN	L-RTL-10DIN	L-DCL-10DIN	DC-10X (1)
SD12R-SP05X-000	12-contact depth	2.4/1.1	1.1	5	L-SRL-12BDIN	L-RTL-12BDIN	L-DCL-12BDIN	DC-12X (1)
MD01R-SP00X-000	1-contact depth	2.4/1.1	1.1	N/A	N/A	N/A	711-LWKDINX	[6' (1.8m) long]
AD04R-SP10X-000	4-contact AXIEM™ depth ^{3,4}	1.3/2.0	2.0	10	L-SRL-4DIN	L-RTL-4DIN	L-DCL-4DIN	DC-4X (1)
AD08R-SP05X-000	8-contact AXIEM™ depth ^{3,4}	1.3/2.0	2.0	5	L-SRL-8DIN	L-RTL-8DIN	L-DCL-8DIN	DC-8X (1)

¹ Each electrode requires either the CABRIO, RoTec or the TECH-ATTACH cable and the quantity of individual connector blocks as indicated.

² Overall length of the contact followed by its diameter (mm).

³ AXIEM™ is a trademark of Medtronic.

⁴ Pending CE mark approval.

■ Manufactured in U.S.A. All dimensions are approximate. All drawings are not to scale. Consult price sheets for current pricing.

AD-TECH® DEPTH ELECTRODE PLACEMENT KITS

- For placement of depth electrodes with stereotactic or frameless systems

Depth Electrode Placement Kits - for Leksell® or CRW™ Stereotactic System® Frames

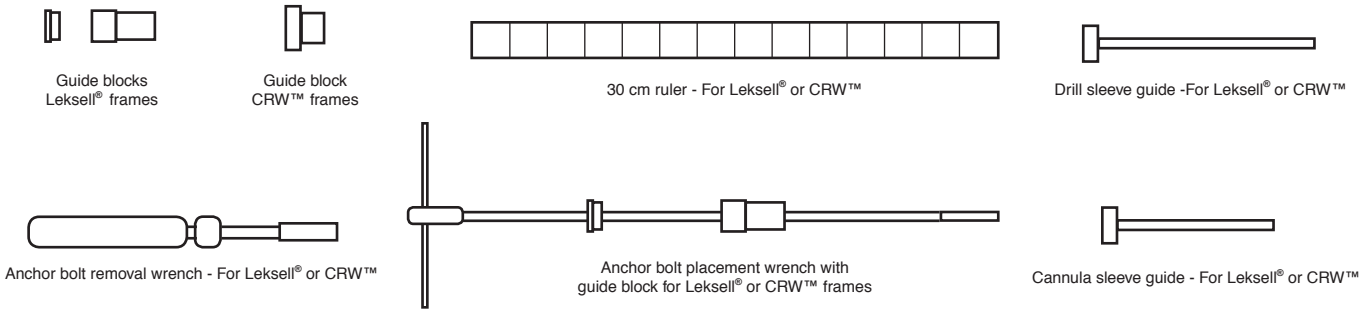

Catalog Number	Description
DPK1-LEKN-PN	Depth electrode placement kit - Leksell® frames. For use with passing needles (see p. 26). Non-sterile; reusable. Sterilize via autoclave. Includes guide blocks, drill sleeve guide, cannula sleeve guide, and ruler.
DPK1-LEKN-AB	Depth electrode placement kit - Leksell® frames. For use with anchor bolts (see p. 26). Non-sterile; reusable. Sterilize via autoclave.
DPK1-CRWN-PN	Depth electrode placement kit - CRW™ frames. For use with passing needles (see p. 26). Non-sterile; reusable. Sterilize via autoclave. Includes guide blocks, drill sleeve guide, cannula sleeve guide, and ruler.
DPK1-CRWN-AB	Depth electrode placement kit - CRW™. For use with anchor bolts (see p. 26). Non-sterile; reusable. Sterilize via autoclave.

Products to work with Medtronic StealthStation®

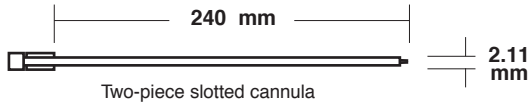

Catalog Number
2SCK1-240X

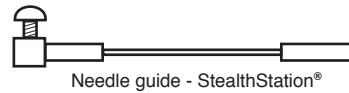

Catalog Number
SNG-AX

Usage
Sterile; reusable
Resterilize via autoclave

Products to work with BrainLab Navigation™ System

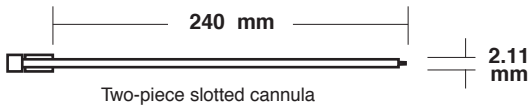

Catalog Number
2SCK1-240X

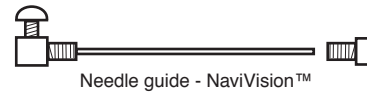

Catalog Number
BLNG-2X

Usage
Sterile; reusable
Resterilize via autoclave

AD-TECH® DEPTH ELECTRODE CANNULAS

- For placement of depth electrodes with stereotactic or frameless systems
- Reusable, resterilize via autoclave

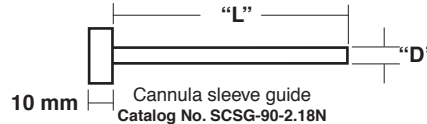
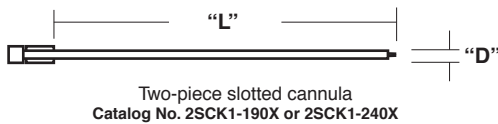

Catalog Number	Description	Diameter "D"	Length "L"	Units
2SCK1-190X	Two-piece slotted cannula, sterile	2.11 mm	190 mm	2 Per Box
2SCK1-240X	Two-piece slotted cannula, sterile	2.11 mm	240 mm	2 Per Box
SCSG-90-2.18N	Slotted Cannula sleeve guide, non-sterile	6.3 mm	90 mm	

- Leksell Stereotactic System® & StealthStation® are registered trademarks of Elekta & Medtronic/Sofamor-Danek respectively. CRW™ and NaviVision™ are trademarks of Radionics & BrainLab.
- Manufactured in U.S.A. All dimensions are approximate. All drawings are not to scale. Consult price sheets for current pricing.
- Guide tube accepts standard SD series depth electrodes only

AD-TECH® DEPTH ELECTRODE ANCHOR BOLTS

- For placement of depth electrodes with stereotactic or frameless systems
- Sterile; single-use only
- Made from titanium
- Individually packaged, 3 per box

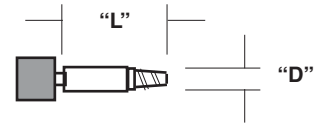

Catalog No. BABK1-LX

Catalog Number	Diameter "D"	Length "L"	Units
BABK1-SX - Use with SD depth electrodes	2.7 - 4.7 mm taper	15 mm	3 Per Box
BABK1-MX - Use with SD depth electrodes	2.7 - 4.7 mm taper	21 mm	3 Per Box
BABK1-LX - Use with SD depth electrodes	2.7 - 4.7 mm taper	25 mm	3 Per Box
LSBK1-AX-04 - Use with RD depth electrodes	2.5 mm	24 mm	3 Per Box
LSBK1-AX-05 - Use with SD depth electrodes	2.5 mm	24 mm	3 Per Box
LSBK1-AX-06 - Use with BF, LD or MM depth electrodes	2.5 mm	24 mm	3 Per Box
LSBK1-BX-04 - Use with RD depth electrodes	2.5 mm	14 mm	3 Per Box
LSBK1-BX-05 - Use with SD depth electrodes	2.5 mm	14 mm	3 Per Box
LSBK1-BX-06 - Use with BF, LD or MM depth electrodes	2.5 mm	14 mm	3 Per Box

AD-TECH® DISPOSABLE DRILL KITS

- Includes two drills, two drills stop and two adjustment wrenches
- For drilling cranial holes using a stereotactic frame
- Sterile, single-use only
- Stainless steel construction
- 30 cm long



Drill stop wrench

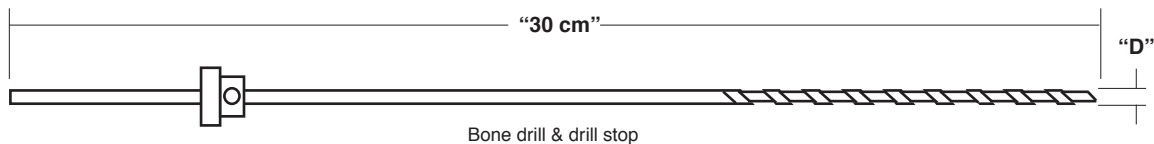

Catalog Number	Diameter "D"	Units
DDK2-2.4-30X	2.4 mm	2 Per Box
DDK2-2.8-30X	2.8 mm	2 Per Box
DDK2-3.2-30X	3.2 mm	2 Per Box

AD-TECH® PASSING NEEDLES

- For tunneling the electrode wire carriers or “tails” away from the surgical site
- Sterile; single-use only

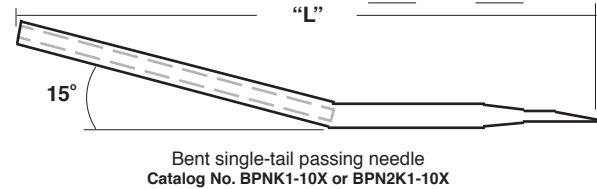
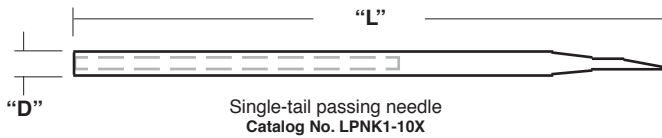
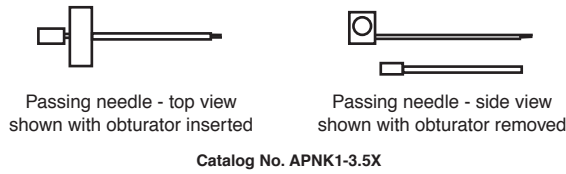

Catalog Number	Description	Diameter “D”	Length “L”	Units
APNK1-3.5X	Passing needle	13 gauge (2.4 mm)	3.5 inch (8.9 cm)	5 Per Box
LPNK1-10X	Single-tail passing needle	0.25 inch (6.4 mm)	10 inch (25.4 cm)	2 Per Box
BPNK1-10X	Bent single-tail passing needle	0.25 inch (6.4 mm)	10 inch (25.4 cm)	2 Per Box
BPN2K1-10X	Bent single-tail passing needle	0.20 inch (5.1 mm)	10.25 inch (26 cm)	2 Per Box

- LPNK1-10X and BPNK1-10X are for 3 or more tails. BPNK2-10X are for 2 tails.
- Manufactured in U.S.A. All dimensions are approximate. All drawings are not to scale. Consult price sheets for current pricing.

AD-TECH® EPILEPSY/LTM SPHENOIDAL ELECTRODES

- Supplied as kits (two electrodes, two introducing needles & two lead wires)
- Two needle lengths available (2.0 inch & 2.75 inches long - 51 mm & 70 mm long)
- 0.011 inch (0.28 mm) stainless steel or 0.007 inch (0.18 mm) platinum wire, 30 cm in length; un-insulated 3-4 mm tip
- 21 gauge (0.033 inch/0.84 mm) needle; other introducing needles available upon request
- Sterile; single-use only

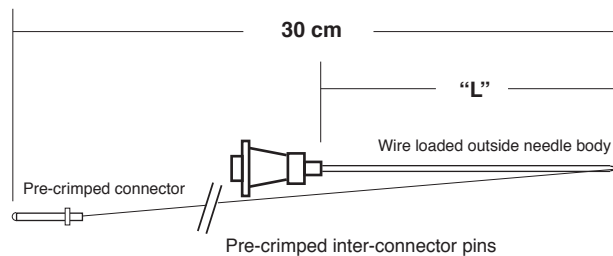

Catalog Number	Description ¹	Electrode Material	Inter-Connector Pin Style	Wire Location	Wire Diameter	Needle length Dimension “L”
711-1DINX-01	Sphenoidal electrode kit	stainless steel	pre-crimped	outside needle	0.011 in (0.28 mm)	2.75 in (70 mm)
711-1DINX-05	Sphenoidal electrode kit	stainless steel	pre-crimped	outside needle	0.011 in (0.28 mm)	2.00 in (51 mm)
711-1PDINX-01	Sphenoidal electrode kit	platinum	pre-crimped	outside needle	0.007 in (0.18 mm)	2.75 in (70 mm)
711-1PDINX-05	Sphenoidal electrode kit	platinum	pre-crimped	outside needle	0.007 in (0.18 mm)	2.00 in (51 mm)

- ¹ Each sphenoidal electrode kit includes two sphenoidal electrodes, two 21 gauge introducing needles and two lead wires. Sterile; single-use only.
- Manufactured in U.S.A. All dimensions are approximate. Drawings are not to scale. Consult price sheets for current pricing.

AD-TECH® SUBPIAL TRANSECTORS

- *Lightweight & disposable*
- *Two different 0.55 mm diameter tip styles (dull & sharp)*
- *Sterile; single-use only*

* **Ad-Tech's Subpial Transectors are NOT CE Marked**

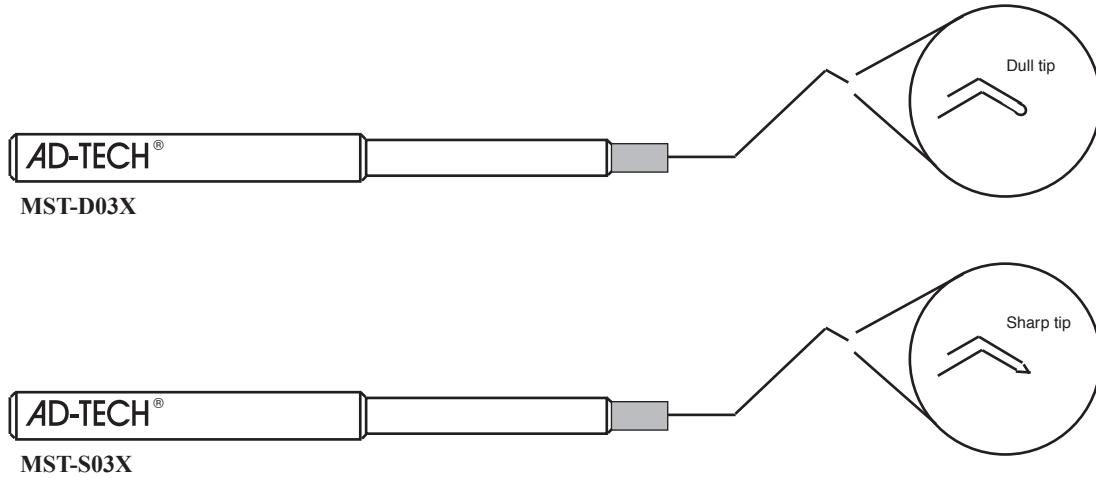

Catalog Number

Description¹

- | | |
|-----------------|---|
| MST-D03X | MST handle with pre-attached dull tip. Box of three individually sterilized units. |
| MST-S03X | MST handle with pre-attached sharp tip. Box of three individually sterilized units. |

¹ All tips have a wire diameter of 0.55 mm. The bent distal portion of all tips is approximately 5 mm long. Sterile; single-use only.

AD-TECH® ELECTRODE CABLE SPLITTER BOX

- *Ad-Tech's new cable splitter box accepts up to 32 channels of input and then splits the signal into two separate 32 channels of output*
- *Includes input sockets for references and grounds*
- *Uses standard 1.5 mm female connectors (inputs & outputs)*

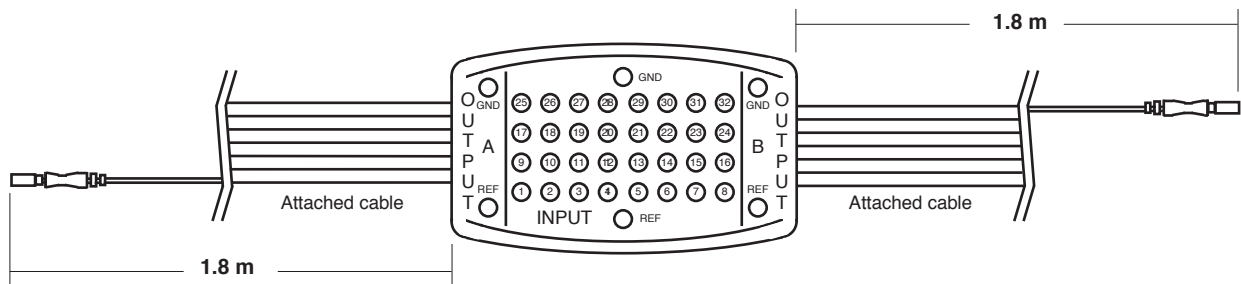

Catalog Number

Description

- | | |
|----------------------|---|
| CLW-32DIN-CSB | 32-channel electrode cable splitter box with cables |
|----------------------|---|

■ *Manufactured in U.S.A. All dimensions are approximate. All drawings are not to scale. Consult price sheets for current pricing.*



AD-TECH® LIGHTWEIGHT ELECTRODE CONNECTION SYSTEMS

- Lightweight and Flexible
- 1.8 m (6 feet) length - additional cable lengths available
- Quick disconnect option available

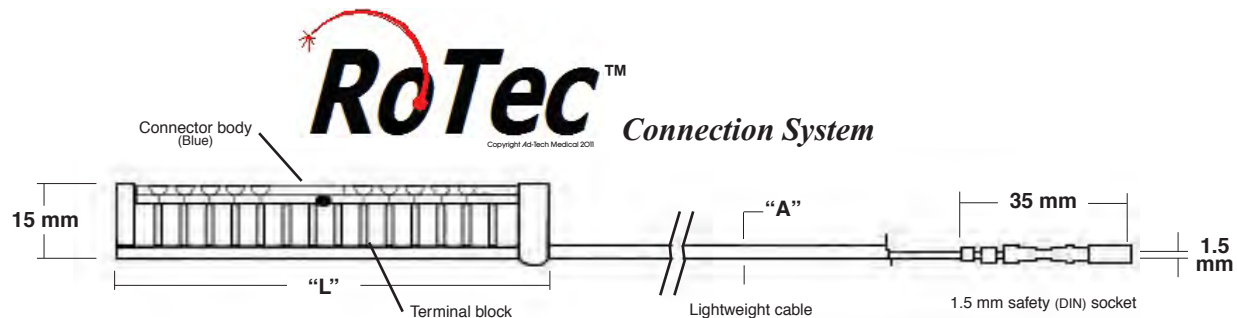

Lightweight RoTec Connection System

Catalog Number	Description ¹	Terminal Configuration	Dimension "L"	Cable Diameter "A"
L-RTL-4DIN	4-contact lightweight RoTec connector/cable	1 terminal of 4	35 mm	2.21 mm
L-RTL-6DIN	6-contact lightweight RoTec connector/cable	1 terminal of 6	35 mm	2.67 mm
L-RTL-8DIN	8-contact lightweight RoTec connector/cable	1 terminal of 8	45 mm	2.67 mm
L-RTL-10DIN	10-contact lightweight RoTec connector/cable	1 terminal of 10	55 mm	3.23 mm
L-RTL-12BDIN	12-contact lightweight RoTec connector/cable	1 terminal of 12	65 mm	3.76 mm
L-RTL-16BDIN	16-contact lightweight RoTec connector/cable	1 terminal of 16	85 mm	3.76 mm
L-RTL-20DIN	20-contact lightweight RoTec connector/cable	2 terminals of 10	55 mm	2 x 3.23 mm
L-RTL-32BDIN	32-contact lightweight RoTec connector/cable	2 terminals of 16	85 mm	2 x 3.76 mm
L-RTL-48BDIN	48-contact lightweight RoTec connector/cable	3 terminals of 16	85 mm	3 x 3.76 mm
L-RTL-64BDIN	64-contact lightweight RoTec connector/cable	4 terminals of 16	85 mm	4 x 3.76 mm

CABRIO® Connection System

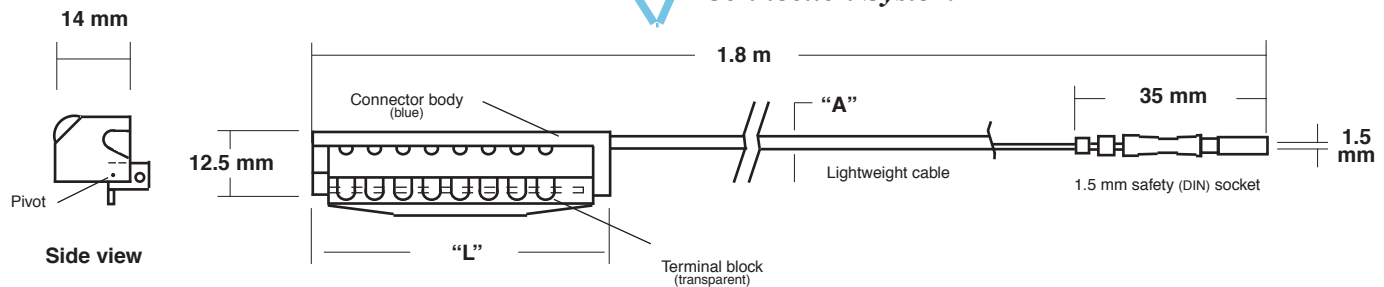

Lightweight CABRIO Connection System

Catalog Number	Description ¹	Terminal Configuration	Dimension "L"	Cable Diameter "A"
L-SRL-4DIN	4-contact lightweight CABRIO connector/cable	1 terminal of 4	34 mm	2.21 mm
L-SRL-6DIN	6-contact lightweight CABRIO connector/cable	1 terminal of 6	44 mm	2.67 mm
L-SRL-8DIN	8-contact lightweight CABRIO connector/cable	1 terminal of 8	54 mm	2.67 mm
L-SRL-10DIN	10-contact lightweight CABRIO connector/cable	1 terminal of 10	64 mm	3.23 mm
L-SRL-12BDIN	12-contact lightweight CABRIO connector/cable	1 terminal of 12	94 mm	3.76 mm
L-SRL-16BDIN	16-contact lightweight CABRIO connector/cable	1 terminal of 16	94 mm	3.76 mm
L-SRL-20DIN	20-contact lightweight CABRIO connector/cable	2 terminals of 10	64 mm	2 x 3.23 mm
L-SRL-32BDIN	32-contact lightweight CABRIO connector/cable	2 terminals of 16	94 mm	2 x 3.76 mm
L-SRL-48BDIN	48-contact lightweight CABRIO connector/cable	3 terminals of 16	94 mm	3 x 3.76 mm
L-SRL-64BDIN	64-contact lightweight CABRIO connector/cable	4 terminals of 16	94 mm	4 x 3.76 mm

- Lightweight Cabrio, RoTec and TECH-ATTACH cables are supplied with 1.5 mm safety sockets. Where not prohibited by law, alternative termination options are available upon request. Non-sterile; sterilize via EtO (EO) or Sterrad.
- Manufactured in U.S.A. All dimensions are approximate. All drawings are not to scale. Consult price sheets for current pricing.



Connection System

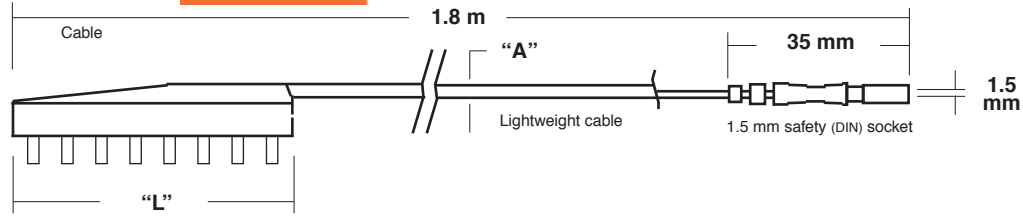

Lightweight TECH-ATTACH Connection System

Catalog Number ²	Description ¹	Terminal Configuration	Dimension "L"	Cable Diameter "A"
L-DCL-4DIN	4-contact lightweight TECH-ATTACH cable	1 terminal of 4	34 mm	2.21 mm
L-DCL-6DIN	6-contact lightweight TECH-ATTACH cable	1 terminal of 6	44 mm	2.67 mm
L-DCL-8DIN	8-contact lightweight TECH-ATTACH cable	1 terminal of 8	54 mm	2.67 mm
L-DCL-10DIN	10-contact lightweight TECH-ATTACH cable	1 terminal of 10	64 mm	3.23 mm
L-DCL-12BDIN	12-contact lightweight TECH-ATTACH cable	1 terminal of 12	66 mm	3.76 mm
L-DCL-16BDIN	16-contact lightweight TECH-ATTACH cable	1 terminal of 16	94 mm	3.76 mm
L-DCL-20DIN	20-contact lightweight TECH-ATTACH cable	2 terminals of 10	64 mm	2 x 3.23 mm
L-DCL-32BDIN	32-contact lightweight TECH-ATTACH cable	2 terminals of 16	94 mm	2 x 3.76 mm
L-DCL-48BDIN	48-contact lightweight TECH-ATTACH cable	3 terminals of 16	94 mm	3 x 3.76 mm
L-DCL-64BDIN	64-contact lightweight TECH-ATTACH cable	4 terminals of 16	94 mm	4 x 3.76 mm

■ Lightweight CABRIO and TECH-ATTACH cables are supplied with 1.5 mm safety sockets. Where not prohibited by law, alternative termination options are available upon request. Non-sterile; sterilize via EtO (EO) or Sterrad.

■ All lightweight TECH-ATTACH cables require the use of disposable connector blocks.

■ Manufactured in U.S.A. All dimensions are approximate. All drawings are not to scale. Consult price sheets for current pricing.

AD-TECH® DISPOSABLE CONNECTOR BLOCKS

- Disposable, sterile

TECH-ATTACH Disposable Connector Blocks (Box of 10)

Catalog Number	Description	Used with Lightweight TECH-ATTACH Cable
DC-2X	2-contact block	L-DCL-2DIN
DC-3X	3-contact block	L-DCL-3DIN
DC-4X	4-contact block	L-DCL-4DIN
DC-5X	5-contact block	L-DCL-5DIN
DC-6X	6-contact block	L-DCL-6DIN
DC-8X	8-contact block	L-DCL-8DIN, -16DIN, -32DIN, -48DIN & -64DIN
DC-10X	10-contact block	L-DCL-10DIN, -20DIN & -40BDIN
DC-11X	11-contact block	L-DCL-35DIN
DC-12X	12-contact block	L-DCL-12BDIN, -24BDIN, -35DIN & -48DDIN
DC-16X	16-contact block	L-DCL-16BDIN, -32BDIN, -48BDIN & -64BDIN

■ All TECH-ATTACH connector blocks are packaged in sets of two with five sets per box. Sold by box of ten only. Sterile; single-use only.
 ■ Manufactured in U.S.A. All dimensions are approximate. All drawings are not to scale. Consult price sheets for current pricing.



Telephone: 262.634.1555 | sales@adtechmedical.com
 Toll Free (USA): 800.776.1555 | www.adtechmedical.com

AD-TECH® DISPOSABLE BRAIN BIOPSY NEEDLES

- Supplied as complete kits (needle, needle stop & aspirator tube with Luer lock; 10 cm models also include a barium sleeve)
- Available in standard lengths: 10 cm, 15 cm, 19 cm & 24 cm (custom lengths available)
- Inner and outer cannula have polished, rounded closed ends
- 14 gauge (0.083 inch/2.11 mm) diameter
- Nominal 5, 8 or 10 mm side cutting window
- Also available in MR-conditional materials
- High quality & low cost
- Sterile; single-use only
- 304 stainless steel with 1 cm markings
- For stereotactic-guided procedures

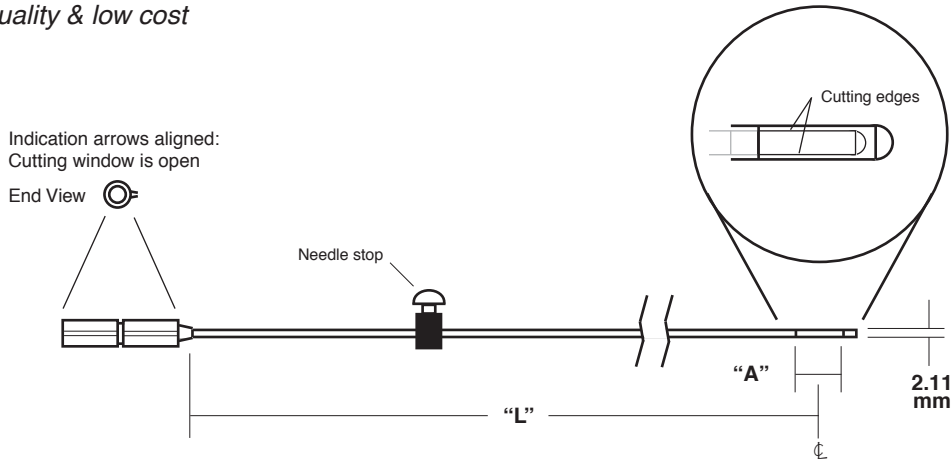

Most Common
Catalog Number
"A" = 8 mm

DBN-08-10X
DBN-08-19X
DBN-08-24X

MDBN-08-10X
MDBN-08-15X
MDBN-08-19X

Catalog Number
"A" = 5 mm

DBN-05-19X

Catalog Number
"A" = 10 mm

DBN-10-24X

Material

stainless steel
stainless steel
stainless steel
MR-conditional¹
MR-conditional¹
MR-conditional¹

Dimension²
"L"

10 cm
19 cm
24 cm
10 cm
15 cm
19 cm

Units

1 Per Box
1 Per Box
1 Per Box
1 Per Box
1 Per Box
1 Per Box

BRAIN BIOPSY NEEDLE GUIDES

- For guiding brain biopsy needles using stereotactic or frameless systems
- High quality & low cost

Catalog Number Units

11980 1 Per Box



Description

DAPII brain biopsy needle guide housing. Requires a guide sphere assembly (see below). Screw mount. Placed through a standard 1.0 - 1.5 cm burr hole. Non-sterile; sterilize via autoclave.

11980-02X 2 Per Box



Guide sphere assembly. Used with biopsy needles *without* barium sleeves. Sterile; single-use only.

11980-PW 1 Per Box

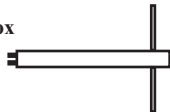

Placement wrench. Used to insert or remove the DAPII needle guide. Non-sterile; sterilize via autoclave.

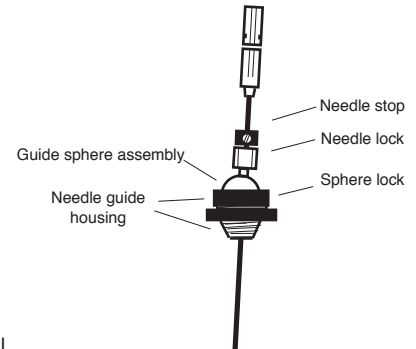

Biopsy needle shown with DAPII needle guide

DISPOSABLE REDUCING GUIDE KITS

- For use with CRW™ stereotactic frames

Catalog Number	Description ²	Length "L"	Kit Contents	Usage
DRGK1-76-5X	Disposable reducing guide kit	76 mm	Box of 5	Sterile; single-use only
DRGK1-116-5X	Disposable reducing guide kit	116 mm	Box of 5	Sterile; single-use only
DRGK1-160-5X	Disposable reducing guide kit	160 mm	Box of 5	Sterile; single-use only

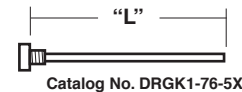

Catalog No. DRGK1-76-5X



Catalog No. DRGK1-116-5X

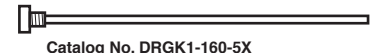

Catalog No. DRGK1-160-5X

¹ Contact your Ad-Tech representative for specific MR-conditional parameters.

² All reducing guide kits needles are 12 gauge (0.109 inch/2.77 mm) in diameter; with an inner diameter of 0.083 inch/2.11 mm. All other dimensions are as stated.

■ Manufactured in U.S.A. All dimensions are approximate. Drawings are not to scale. Consult price sheets for current pricing.

AD-TECH® CUEVA INTRAOPERATIVE CRANIAL NERVE ELECTRODES

- For direct cranial nerve monitoring during skull base surgeries
- Circumferential design, 2.0mm or 3.0mm diameter “C-Shaped” electrode
- Supplied in complete sterile kits
- Platinum contacts
- Easy-to-use applicator, 250 mm long
- Highly-consistent amplitude; real-time status
- 2.35 mm diameter platinum contact electrode (for the middle fossa approach)
- Sterile; single-use only

* Ad-Tech’s Cranial Nerve Electrodes are NOT CE Marked

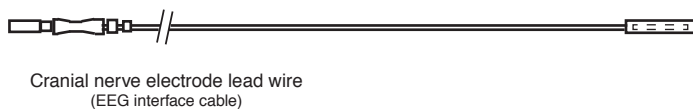
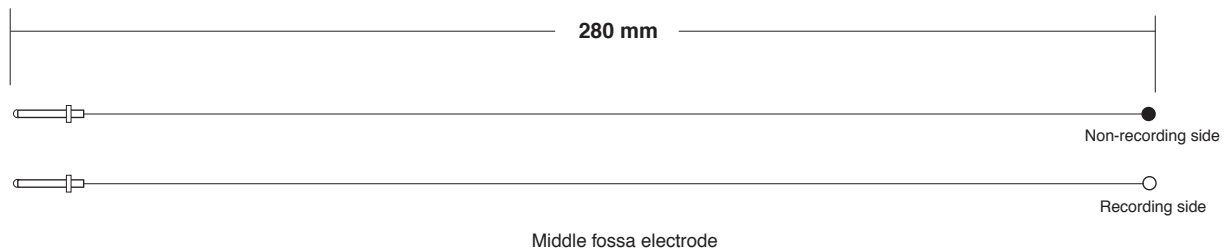
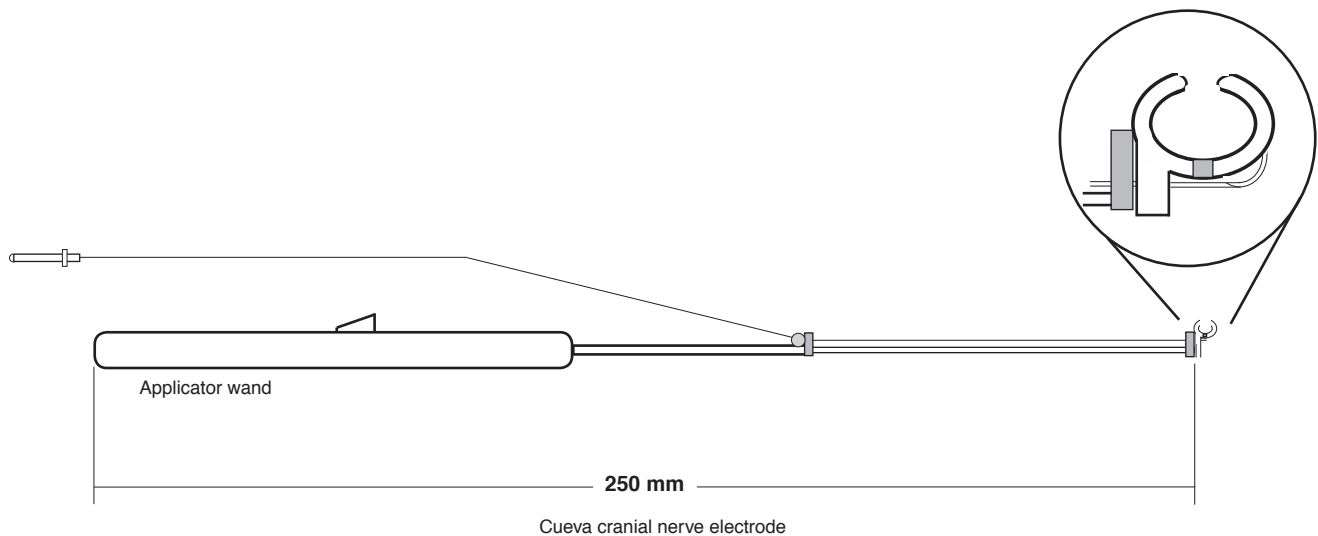

Catalog Number	Units	Description
CNE1-2KDINX	2 Per Box	2 mm cranial nerve electrode kit
CNE1-3KDINX	2 Per Box	3 mm cranial nerve electrode kit
CNE1-1SKDINX	2 Per Box	Middle fossa electrode kit

- Each cranial nerve electrode kit includes two 2.0 mm or 3.0 mm cranial nerve electrodes, one 25 cm long applicator wand, and one 6 foot (1.8 m) lead wire terminating in a 1.5 mm safety socket. Sterile; single-use only.
- Each middle fossa electrode kit includes two electrodes, and two 6 foot (1.8 m) lead wires terminating in a 1.5 mm safety socket. Sterile; single-use only.
- All lead wires are 6 feet (1.8 m) long. All lead wires interface with standard EEG/EP amplifiers using 1.5 mm safety sockets.
- Manufactured in U.S.A. All dimensions are approximate. Drawings are not to scale. Consult price sheets for current pricing.



AD-TECH® IVES CT COMPATIBLE, NON-FERROUS ELECTRODES

- Conductive plastic cup bodies with a low-noise Ag-AgCl coating
- Completely non-ferrous
- CT compatible
- Standard 10 mm diameter cups
- Color and length coded wires conform to 10:20 system
- Easy connection to harness
- Collodion[®] for long-term use
- Non-sterile; reusable

* Ad-Tech's Ives CT Compatible, Non-Ferrous Electrodes are NOT CE Marked



Actual recording obtained from using the IES-CPE-20N Conductive Plastic Electrode Set

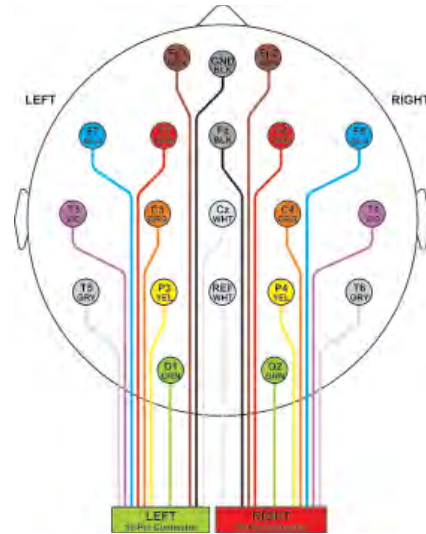

IES-CPE-20N Conductive Plastic Electrode Set Electrode Placement - 10:20 System

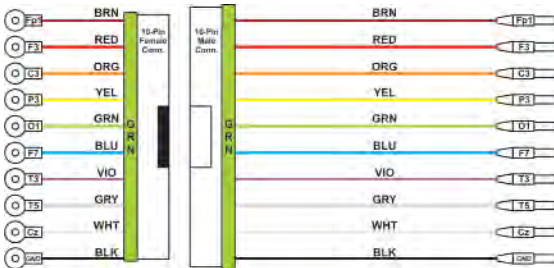

IES-CPE-20N Conductive Plastic Electrode Set & IES-HAR-20N EEG Interface Harness

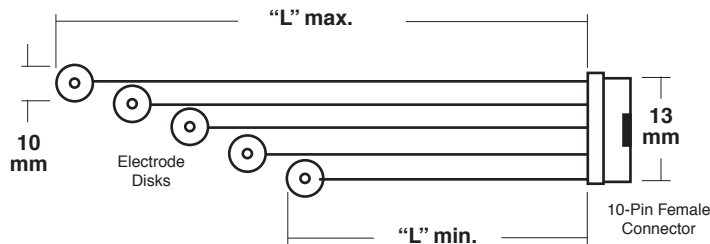
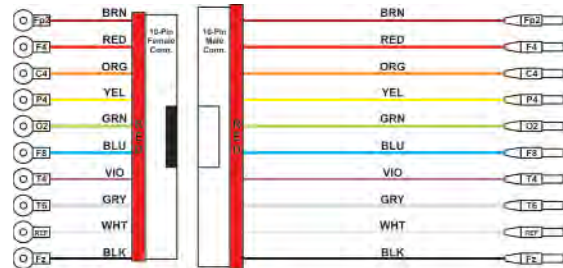

IES-CPE-20N Conductive Plastic Electrode Set

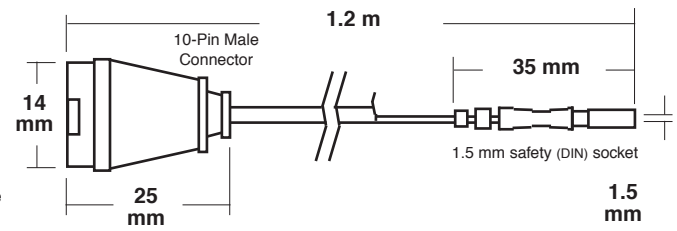

IES-HAR-20N EEG Interface Harness

Catalog Number	Description	Material	Dimension Diameter	Leadwire Length "L"
IES-CPE-20N	20-contact conductive plastic electrode set ¹	ABS plastic body Ag-AgCl coating	10 mm	15 - 28 cm
IES-HAR-20N	20-contact EEG interface harness ²			1.2 m

¹ Each conductive plastic electrode set includes one red and one green, color-and length-coded, labeled 10-channel electrode assembly and two replacement (spare) EEG electrode disks and wires. Non-Sterile; not intended for sterilization, Reusable.

² Each EEG interface harness includes one red and one green, color-coded and labeled 10-channel harness assembly. Non-Sterile; not intended for sterilization, Reusable.

³ Use non acetone for removing electrodes.

AD-TECH® IVES SUBDERMAL WIRE ELECTRODES

- Silver wire electrodes with a low-noise Ag-AgCl coating
- Completely non-ferrous
- 25-gauge introducing needles
- Color-and length-coded wires conform to 10:20 system
- Easy connection to harness
- Non-sterile; single-use only

* Ad-Tech's Ives Subdermal Wire Electrodes are NOT CE Marked

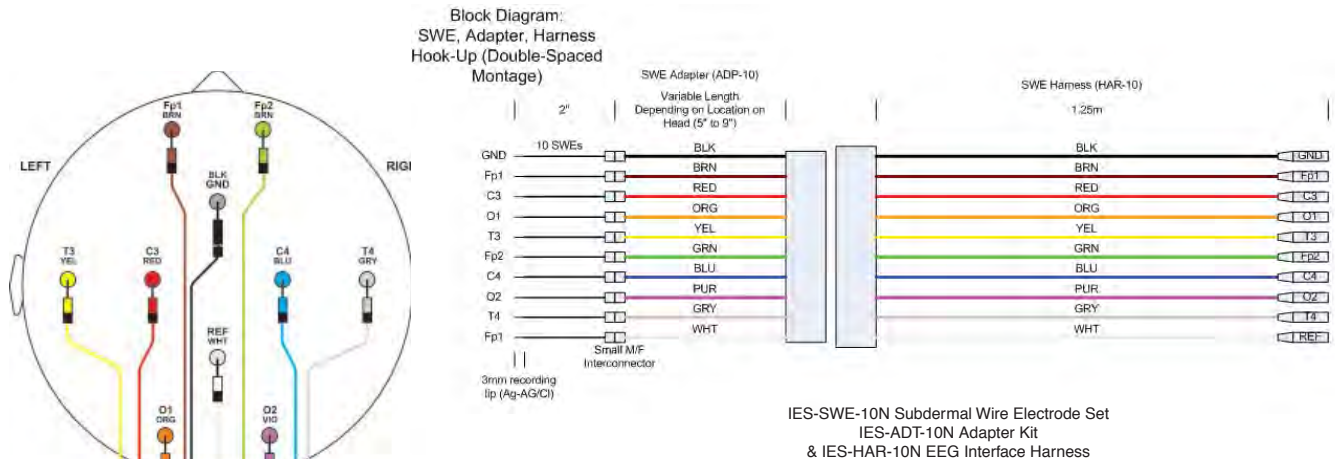

IES-SWE-10N Subdermal Wire Electrode Set
& IES-ADT-10N Adapter Kit

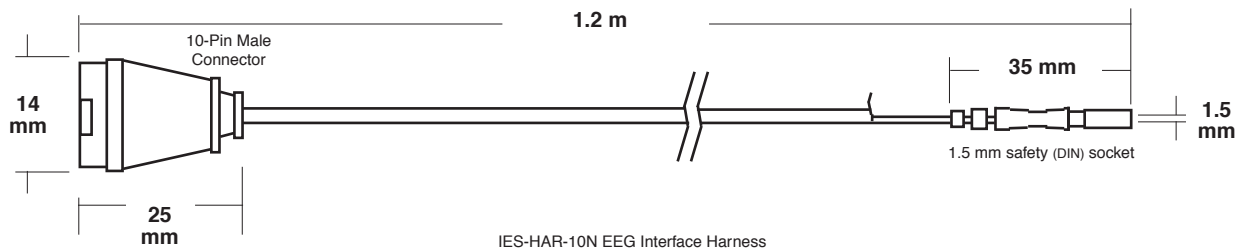
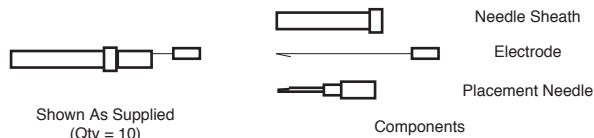

Catalog Number	Description	Material	Dimension Diameter	Length "L"
IES-SWE-10N	10-contact subdermal wire electrode set ¹	Ag-AgCl wire	0.25 mm	4.5 cm
IES-ADT-10N	10-contact adapter kit ²		25 gauge	12 - 23 cm
IES-HAR-10N	10-contact EEG interface harness ³			1.2 m

¹ Each subdermal wire electrode set includes ten Ag-AgCl wire electrodes, ten introducing needles, and ten needle sheaths. Non-Sterile; sterilize via EtO. Disposable. Single-Use Only.

² Each adapter kit includes one color- and length-coded, labeled 10-channel electrode assembly. Non-Sterile; not intended for sterilization, Reusable.

³ Each EEG interface harness includes one color-coded and labeled 10-channel harness assembly. Non-Sterile; not intended for sterilization, Reusable.

■ Contact your AD-TECH representative for information on MR testing.



Telephone: 262.634.1555
Toll Free (USA): 800.776.1555

sales@adtechmedical.com
www.adtechmedical.com

NOTES

ITEMS REGULARLY ORDERED:



"The patient is our thought in device design through device use."



AD-TECH[®]

www.adtechmedical.com

1901 William Street - Racine, WI 53404
United States of America